

## DIGITAL CLOCK DISTRIBUTOR

523

### DESCRIPTION AND SPECIFICATIONS

CONTENTS	PAGE	CONTENTS (Contd)	PAGE
1. GENERAL .....	2	D. ST3 Card .....	37
2. INTRODUCTION .....	3	E. TNC-E Card .....	37
3. DESCRIPTION .....	4	F. TNC Card .....	38
A. Master Shelf .....	6	G. LNC Card .....	39
B. Expansion Shelf .....	8	8. TIMING OUTPUT CARD DECRPTIONS. ....	39
C. Remote Wire-wrap Panel .....	9	A. EA10 Card .....	39
D. Remote System .....	10	B. EA10M Card .....	41
E. DCD-LPR .....	10	C. TOAA Card .....	41
F. Cards .....	11	D. TOCA Card .....	41
G. Interface Panels and Interface Modules .....	17	E. TOGA Card .....	41
H. Bridging Isolator Module .....	19	F. TO-EA5 Card .....	41
I. Card Quantities .....	19	G. TO-EA Card .....	43
4. SYSTEM DESCRIPTION .....	21	H. TO-EAN Card .....	43
A. System Architecture .....	21	I. TOEA Card .....	44
B. System Power .....	21	J. TOLA Card .....	44
C. Input Signals .....	21	K. TOTL Card .....	44
D. Clocks .....	21	L. TOTA and TOTA-5 Cards .....	45
E. Reference Monitoring .....	23	M. TOTA-M Card .....	46
F. Timing Output .....	23	9. MCA-5M CARD AND OUTPUT PROTECTION MATRIX .....	46
G. Output Protection .....	23	10. MCA-5 CARD AND OUTPUT PROTECTION MATRIX .....	47
H. Synchronous Clock Insertion .....	24	11. INSERTION CARD DESCRIPTIONS .....	48
I. SSM .....	25	A. SCIU Card .....	48
5. ALARM AND MAINTENANCE CARD DESCRIPTIONS .....	25	B. ESCIU Card .....	50
A. SAI Card .....	25	12. PSM CARD DESCRIPTION .....	51
B. MIS Card .....	26	13. SPECIFICATIONS .....	52
6. CLOCK INPUT CARD DESCRIPTIONS ....	28	Figures	
A. CI-EA Card .....	28	1. DCD-523 Rack Layout .....	5
B. CI Card .....	29	2. Master Shelf Equipped with Rubidium Clock Cards .....	6
C. ACI Card .....	29	3. Master Shelf Equipped with Quartz Clock Cards .....	7
D. DCIM Cards .....	30	4. Expansion Shelf .....	8
E. MRC Card .....	31		
7. CLOCK CARD DESCRIPTIONS .....	34		
A. ST2E Card .....	34		
B. ST2 Card .....	35		
C. ST3E Card .....	36		

Figures (Contd)	Page
5. DCD Shelf Wire-wrap Panel to Remote Wire-wrap Panel Connection . . . . .	9
6. Master to Remote System Connection . . . . .	10
7. DCD-523 to DCD-LPR Connection . . . . .	10
8. ANSI-Class MMP . . . . .	17
9. Wire-wrap Panel . . . . .	17
10. ITU-Class MMP . . . . .	18
11. ITU-Class Output MMP . . . . .	18
12. Remote Wire-wrap Panel . . . . .	18
13. E1 Bridging Isolator Module . . . . .	19
14. Wire-wrap Bridging Isolator Module . . . . .	19
15. DCD-523 System . . . . .	22

**Tables**

A. DCD-523 System Cards . . . . .	12
B. Protection Modes for Output Cards . . . . .	15
C. Slot Covers. . . . .	15
D. 1:N TO Card Incompatibility . . . . .	15
E. 1:N TOTA Card Compatibility with MCA-5M Card. . . . .	16
F. Card Quantities (Max Number per Shelf)	20
G. Priority of Internal Timing Signals . . . . .	23
H. Valid SSM Clock Input Card Combinations . . . . .	25
I. Invalid SSM Clock Input Card Combinations . . . . .	25
J. Cards Incompatible with MIS <sup>V5</sup> . . . . .	26
K. Cards Incompatible with Non-Version 5 MIS . . . . .	27
L. PSM Card Factory Threshold Settings for MTIE and TDEV . . . . .	52
M. System Specifications . . . . .	53
N. Bridging Isolator Specifications . . . . .	55
O. Card Specifications . . . . .	56
P. Specification Terms . . . . .	80

**1. GENERAL**

**1.01** This section provides descriptions and specifications for the Digital Clock Distributor 523 (DCD-523) System.

**1.02** This section was reissued for the reasons listed below. Changes and additions are marked by change bars.

- Changed Table A to show the correct part number of the TO-EA5<sup>V5</sup> card.
- Changed Table O to correct information for the TOAA card.

**1.03** Symmetricom is a registered trademark of Symmetricom, Inc. DCD and Version 5 are trademarks of Symmetricom, Inc. All other product names, service marks, trademarks, and registered trademarks used in this document are the property of their respective owners.

**1.04** The following abbreviations are used in this document:

AIS	alarm indication signal
AMI	alternate mark inversion signal
B8ZS	bipolar 8-zero substitution
BITS	Building Integrated Timing Supply
BPV	bipolar violation
CAS	channel associated signaling
CCS	common channel signaling
CRC-4	cyclic redundancy check
D4	D4 framing format
DCD	Digital Clock Distributor
DCE	Data Communications Equipment
DS1	digital signal, level 1 (1.544 Mb/s)
DSX-1	digital cross-connect, level 1
E1	European Signal, level 1 (2.048 Mb/s)
ESF	extended superframe
GPS	global positioning system
HDB3	high density binary 3
HS	hot spare (card or slot)
ITU	International Telecommunication Union
LNC	Local Node Clock
LOS	loss of signal
LPR	Local Primary Reference
MMP	modular mounting panel
MTIE	Maximum Time Interval Error
OEXO	oven-controlled crystal oscillator
OOFF	out-of-frame
PRC	primary reference clock
SASE	Stand-alone Synchronization Equipment
SDH	Synchronous Digital Hierarchy
SSM	Synchronization Status Message
SSU	Synchronization Supply Utility
T1	digital transmission link (1.544 Mb/s)

TDEV	Time Deviation
TL1	Transaction Language 1
TNC	Transit Node Clock
TO	Timing output (card or slot)
VCXO	voltage-controlled crystal oscillator

**Notes:**

1. Where information is common to the MRC-EA<sup>V5</sup> (p/n 090-45010-56, -57), MRC-T<sup>V5</sup> (p/n 090-45010-53, -54, -58), MRC-EA (p/n 090-45010-06, -09), MRC-T (p/n 090-45010-03, -08), ACI, CI-EA, CI, DCIM-T, and DCIM-EA cards, these cards are collectively referred to as clock input cards.
2. Where information is common to the DCIM-T and DCIM-EA cards, these cards are collectively referred to as DCIM cards.
3. Where information is common to the MRC-EA<sup>V5</sup>, MRC-T<sup>V5</sup>, MRC-EA, and MRC-T cards, these cards are collectively referred to as MRC cards.
4. Where information is common to the PSM-E<sup>V5</sup> (p/n 090-45025-52), PSM-EA<sup>V5</sup> (p/n 090-45025-54), PSM-T<sup>V5</sup> (p/n 090-45025-51), PSM-E (p/n 090-45025-02), and PSM-T (p/n 090-45025-01 and 090-45025-53) cards, these cards are collectively referred to as PSM cards.
5. Where information is common to the TNC-E, TNC, LNC, ST2, ST2E, ST3E, and ST3 cards, these cards are collectively referred to as clock cards.
6. Where information is common to the TNC-E, ST2, and ST2E cards, these cards are collectively referred to as rubidium clock cards.
7. Where information is common to the TNC, LNC, and ST3E cards, these cards are collectively referred to as quartz clock cards.
8. Where information is common to the MIS<sup>V5</sup> (p/n 090-45018-05) and MIS (p/n 090-45018-04 and

090-45018-14) cards, these cards are collectively referred to as MIS cards.

9. Where information is common to the MCA-5 and MCA-5M cards, these cards are collectively referred to as MCA cards.
10. Where information is common to any modular mounting panel and the wire-wrap panel, these panels are collectively referred to as interface panels.
11. The Enhanced Transit Node Clock (TNC-E) card and the Enhanced Stratum-2 (ST2E) clock card are identical in specifications, functions, controls and indicators, and acceptance test procedures. The TNC-E name uses ITU standard terminology; the ST2E name uses ANSI standard terminology. The TNC-E and ST2E are interchangeable.

**2. INTRODUCTION**

**2.01** The DCD-523 serves as the SASE or BITS that is a common source for the frequency and phase synchronization necessary in any digital network element (transmission or switching).

**2.02** The SASE/BITS distributes all timing (frequency and phase) required by other clocks within that building. An SASE/BITS may receive its reference signal(s) from either a local Primary Reference G.811 clock (PRC), a network timing interface (reference connection), or another SASE/BITS. The reference signals must be generated from a clock of equal or greater accuracy than the SASE/BITS that uses the reference. Under normal operating conditions, all clock signals are PRC compliant with ITU recommendation G.811.

**2.03** The DCD clocks within the DCD-523 provide long-term averaging of the input reference. If the input is disrupted or is out of tolerance, the DCD clock provides the necessary bridge in timing (holdover) and allows the network to continue to operate slip-free for several hours or days, depending on the clock

**2.04** The DCD-523 provides system-wide synchronization via E1, DS1, analog, CC, and/or TTL/RS-422 output timing signals. The DCD-523 regenerates a clocking signal from its input reference and buffers short-term timing variations. The DCD-523 also permits unrestricted 64 kb/s cross-connection between equipment within an office.

**2.05** DS1 or E1 output timing signals use a framed, all-ones format. Analog output can be used for digital switches, radio, and FDM carriers. An E1 clock signal can be inserted into a traffic-bearing facility, synchronizing the facility to the DCD-523 timing signal.

**2.06** The DCD-523 provides synchronized distribution of timing signals for channel banks, digital switches, PBXs, digital cross-connect systems, SDH terminals, ISDN hardware, and other devices that interconnect with a digital network.

**2.07** The DCD-523 can perform nonintrusive monitoring, measurement, and data-processing functions. Its data gathering capabilities can be interfaced to the customer's Operations Support System (OSS) network via TL1. This gives users the ability to monitor and gather performance data on their synchronization network from a remote monitoring center. An example would be the use of Symmetricom's PC application, the TimeScan, used with the MIS card to interface with the DCD-523.

**2.08** The DCD-523 can interface with Symmetricom's DCD-LPR and DCD-Cs. Either source is a PRC. The DCD-LPR uses reference signals from the Global Positioning System (GPS) satellites and is a G.811 source traceable to Universal Coordinated Time (UTC). The DCD-Cs is a self-contained cesium timing source.

### 3. DESCRIPTION

**3.01** The DCD-523 Systems are designed for modular growth. A DCD-523 System can be as simple as one master shelf. Up to three expansion shelves can be added to the master shelf, and output slots may be equipped as needed.

**3.02** A fully equipped master or expansion shelf, depending on whether it is configured for protected or unprotected outputs, may require up to two interface panels (see Figure 1). An interface panel can be a wire-wrap panel or a modular mounting panel (MMP). Two MMPs, two wire-wrap panels, or a combination of the two per shelf may be used. Each shelf (master and expansion) comes equipped with one interface panel. Additional interface panels may be ordered.

**3.03** If additional outputs are needed, a remote system can be installed. A remote system is a DCD-523 System in another rack that uses timing outputs from the master system. The master and expansion shelves are usually mounted in the same rack, within the reach of the inter-shelf ribbon cables.

**3.04** Two versions of DCD-523 Shelf exist. One version of the shelf (090-45230-03) allows for "hitless" switching of the timing signals to a hot spare when TOCA or TOTA-5 cards are installed. The other version of the shelf (090-45230-01) momentarily breaks the output while switching from the TO card to an HS card. Both shelves are otherwise identical.

**3.05** The shelves in the DCD-523 System house modular cards that:

- accept reference inputs and provide for protection switching of faulty references
- regenerate a highly stable frequency or timing signal
- produce timing signal and time code outputs in several formats
- insert a synchronization clock signal into a traffic-bearing DS1 or E1 data stream
- provide for protection switching of faulty timing signal and time code outputs
- centralize the command and control interface for the DCD-523 System
- operate in conjunction with a DCD-LPR to provide primary reference sources

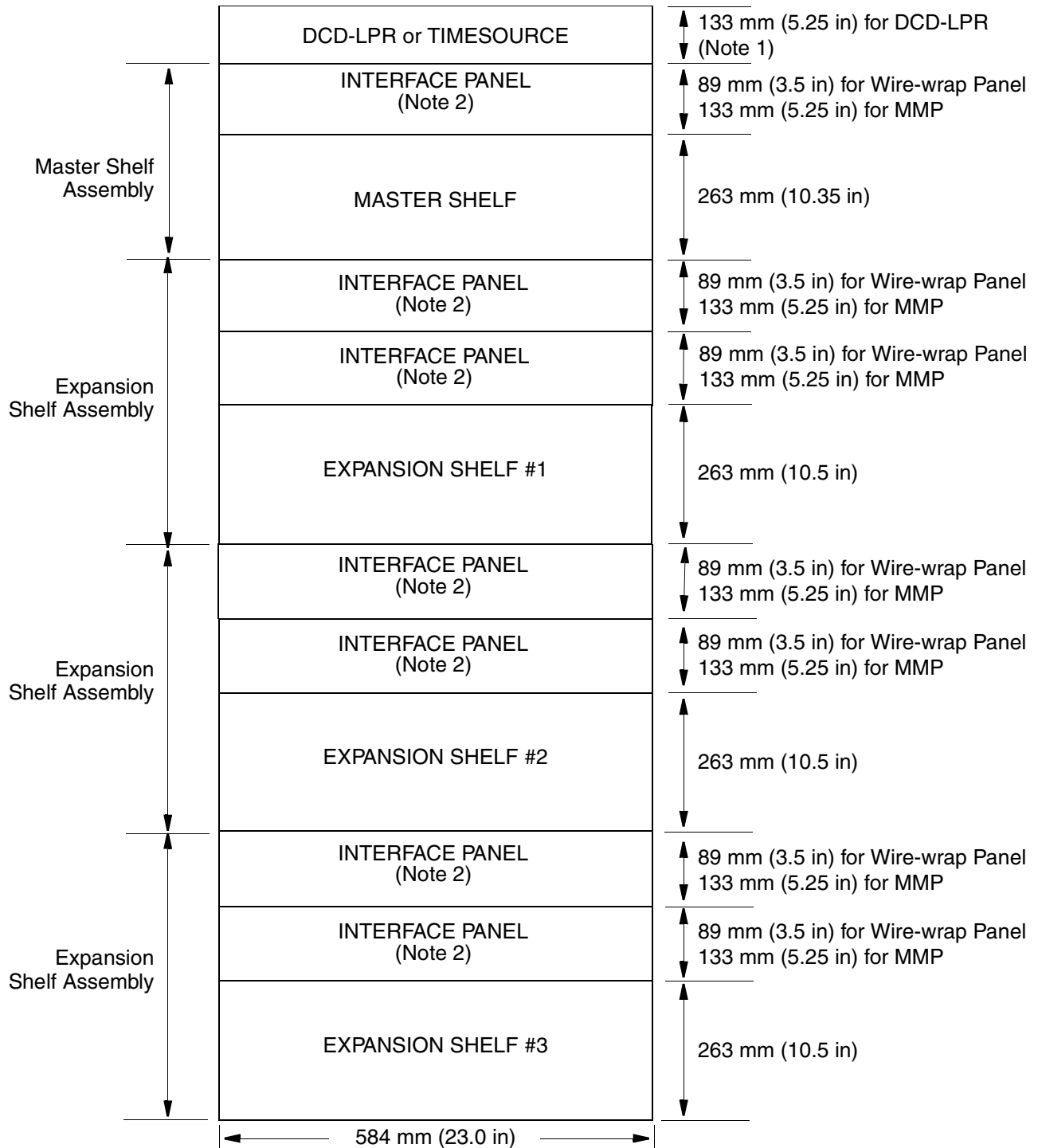

Notes:

1. A fully equipped unprotected expansion shelf requires two interface panels.
2. Interface panels can be a wire-wrap panel, or an MMP panel containing selected modules to accommodate the needs of different timing input and output cards installed in the shelves.
3. A fully equipped unprotected expansion shelf requires two interface panels.

Figure 1. DCD-523 Rack Layout

**A. Master Shelf**

**3.06** All DCD-523 Systems have a master shelf equipped with an interface panel. This shelf accepts reference inputs, develops a stable frequency or timing signal, and provides the central system alarm and maintenance interface. A matrix card in the shelf switches the timing signal from a faulty output card to a single hot spare output card in a 1:N protection mode.

**3.07** The master shelf houses the following cards:

- Clock input
- Clock
- Timing output
- Clock insertion
- Precision Synchronization Monitor (PSM)
- Matrix controller
- Alarm/Maintenance

**3.08** For a shelf with 1:N protection of outputs, use slots TO1 through TO10 for protected or unprotected timing output (TO) cards. Unprotected clock insertion and PSM cards may be installed. Use HS1 and HS2 for hot spares to protect TO cards.

**3.09** If 1:N protection is not used, the HS1 and HS2 slots may be used for active TO, clock insertion, and PSM cards. Do not install an MCA card in a shelf that does not use 1:N protection.

**3.10** For card pairs with redundant protection of outputs, use only slot pairs TO1/TO2, TO3/TO4, TO5/TO6, TO7/TO8, TO9/TO10, and HS1/HS2.

**3.11** Cabling requirements for outputs that are unprotected differ from outputs with redundant protection.

**3.12** Figure 2 shows the master shelf equipped with rubidium clock cards; Figure 3 shows the master shelf equipped with quartz clock cards.

**Note:** Use the MCA slot for an MCA card only.

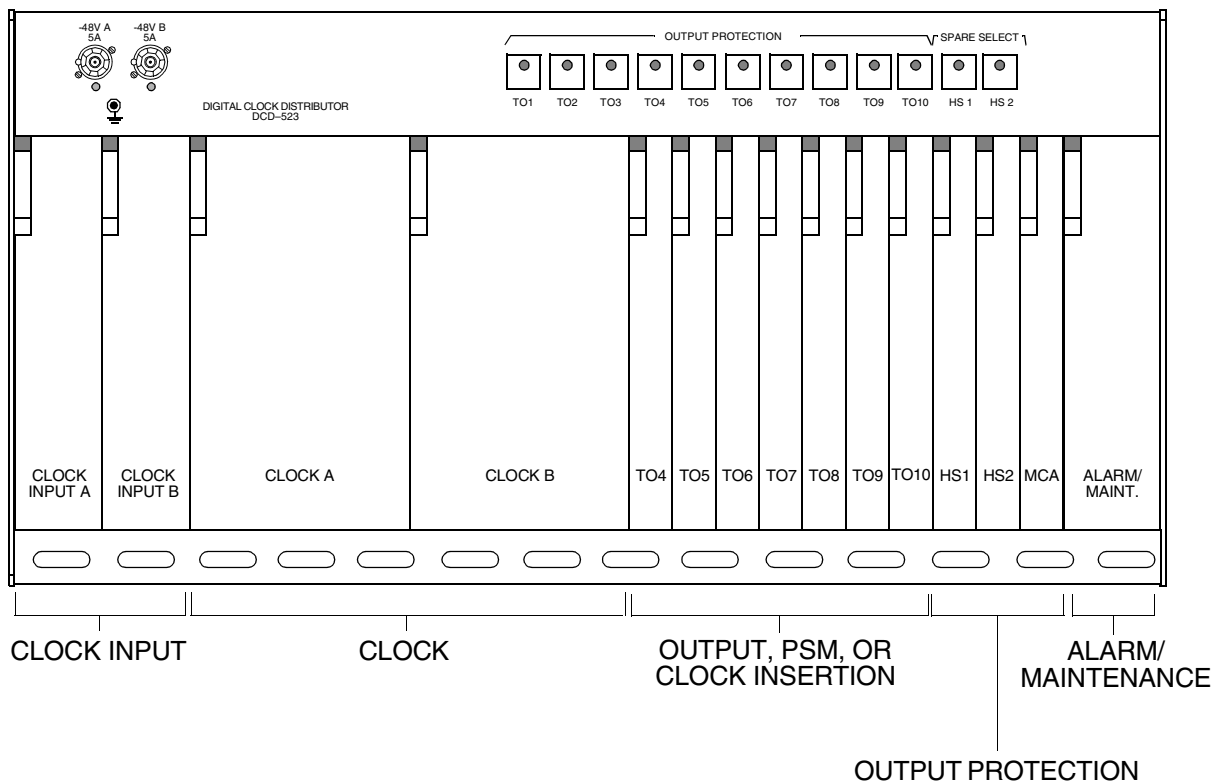

**Figure 2. Master Shelf Equipped with Rubidium Clock Cards**

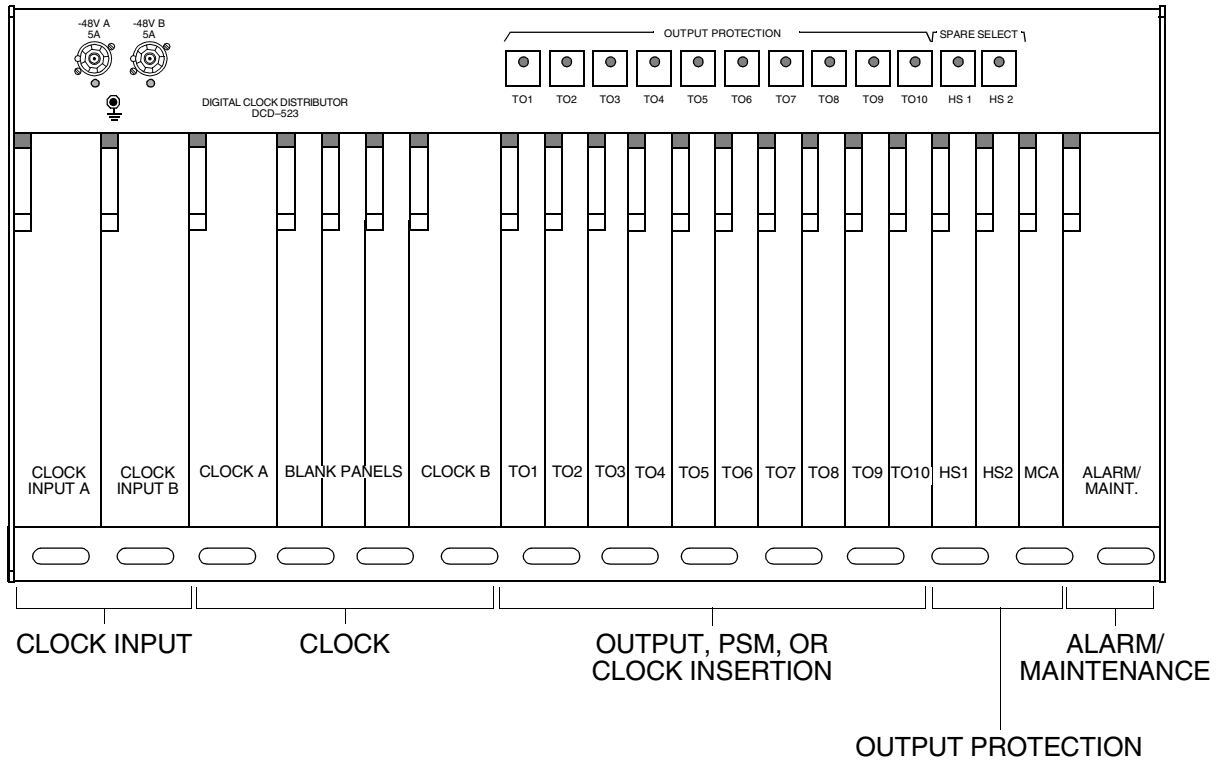

Figure 3. Master Shelf Equipped with Quartz Clock Cards

**B. Expansion Shelf**

**3.13** Up to three expansion shelves (Figure 4) can be used with each master shelf. Each expansion shelf comes equipped with one interface panel; additional interface panels may be ordered if the number of required outputs on a single shelf exceeds the maximum interface card capacity. An MCA card in the shelf switches the timing signal from a faulty output card to a HS TO card. Each expansion shelf can house the following cards:

- Timing output
- Clock insertion
- Matrix controller
- Alarm/Maintenance
- Precision Synchronization Monitor

**3.14** For a shelf with 1:N protection of outputs, use slots TO1 through TO10 for protected or unprotected timing output (TO) cards. Unprotected clock insertion and PSM cards may be installed. Use HS1 and HS2 for hot spares to protect the TO cards.

**3.15** If 1:N protection is not used, the HS1 and HS2 slots may be used for active TO, clock insertion, and PSM cards. Do not install an MCA card in a shelf that does not use 1:N protection.

**3.16** For card pairs with redundant protection of outputs, use only slot pairs TO1/TO2, TO3/TO4, TO5/TO6, TO7/TO8, TO9/TO10, and HS1/HS2. Cabling requirements for outputs that are unprotected differ from outputs with redundant protection.

**Note:** Use the MCA slot for an MCA card only.

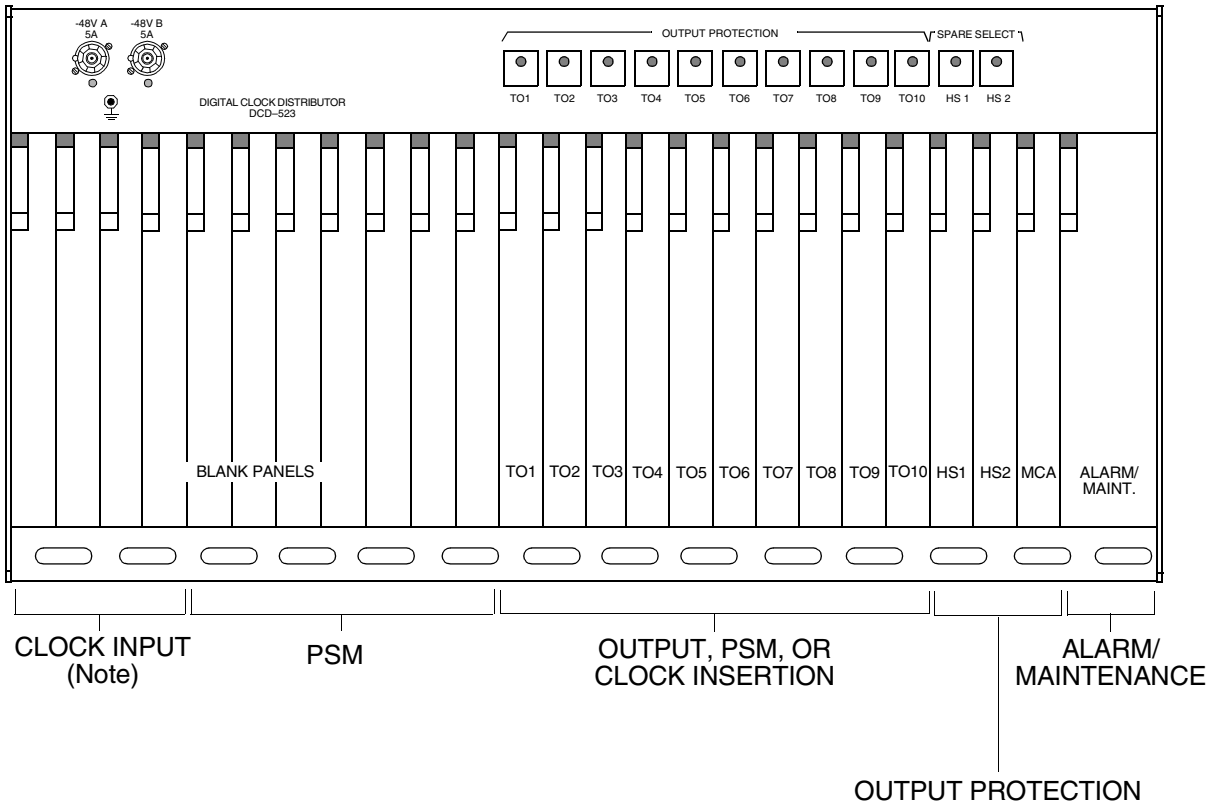

Note: Timing for the expansion shelf is provided by the master shelf, so clock input cards are not required.

**Figure 4. Expansion Shelf**



**C. Remote Wire-wrap Panel**

**3.17** Another method of adding outputs is via a remote wire-wrap panel. The remote wire-wrap panel is designed to be mounted in network element bays remote from the DCD-523 rack (see Figure 5).

**3.18** The remote wire-wrap panel is used when a cluster of NEs are located in another location in the building, especially on a different floor. It is more efficient to run one or two 25-pair cables to the remote wire-wrap panel located in the NE cluster, than to run multiple, individually shielded twisted pair cables directly from the DCD Shelf to each NE in the cluster.

**3.19** The overall distance between the DCD Shelf, the remote wire-wrap panel, and the NEs being timed should not exceed 457 meters (1500 feet) for TOCA outputs, and 200 meters (655 feet) for TOTA outputs.

**3.20** The remote wire-wrap panel is capable of carrying up to 100 DCD outputs. However, it is recommended that no more than 40 outputs be remote from any one shelf. If more than 40 outputs are required, a remote shelf system should be installed.

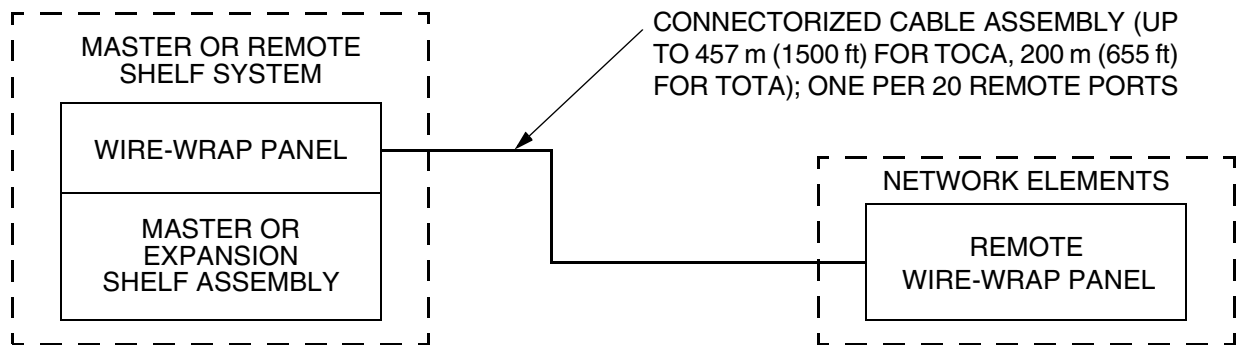

**Figure 5. DCD Shelf Wire-wrap Panel to Remote Wire-wrap Panel Connection**

**D. Remote System**

**3.21** The DCD-523 System can act as a timing master to drive remote DCD-523 Systems (Figure 6). Remote systems can locate timing outputs closer to their destinations. One remote system can maintain full communications with an Operations Support System (OSS) through the master system.

**3.22** A remote system consists of a master shelf located in another rack in the same building. If communications are not required, remote systems may contain a master shelf and up to three expansion shelves, set up the same way as a master system.

**3.23** The master and remote systems can be equipped for phase-aligned timing signals (via an output apiece from two TOGA cards) or G.703 timing signals (via an output apiece from two TOEA or

TOGA cards). For additional information, refer to the Installation section of this manual.

**3.24** In case the signals from the master system fail, one or two ST3 clock cards may be installed in the remote system master shelf to provide holdover timing during a signal interruption.

**E. DCD-LPR**

**3.25** A DCD-LPR System can be used in association with a DCD-523 System to create an integrated Local Primary Reference source and distribution synchronization system (Figure 7). The DCD-LPR Shelf should be located in the rack space immediately above the DCD-523 master shelf. The DCD-LPR requires two inputs that can be supplied by the DCD-523 System.

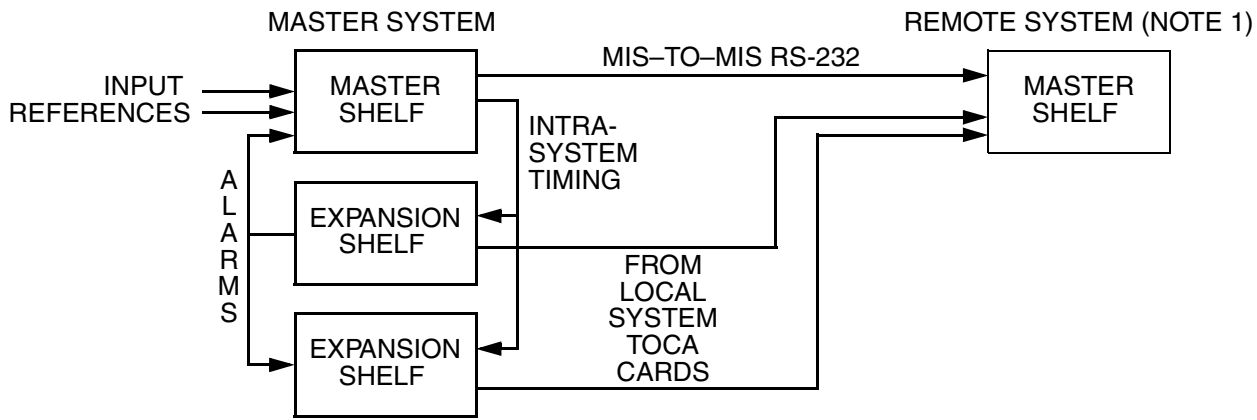

Notes:

1. The remote system master shelf must be equipped with two clock input cards optioned to accept two feeds from the DCD-523 master system. The remote system may be equipped with one or two clock cards (ST3 cards are required for phase-aligned systems) to provide timing holdover if a fault occurs.
2. If communications outside the system are not required, the MIS-to-MIS cable is not required, and both the master system and the remote system may have up to three expansion shelves apiece.

**Figure 6. Master to Remote System Connection**

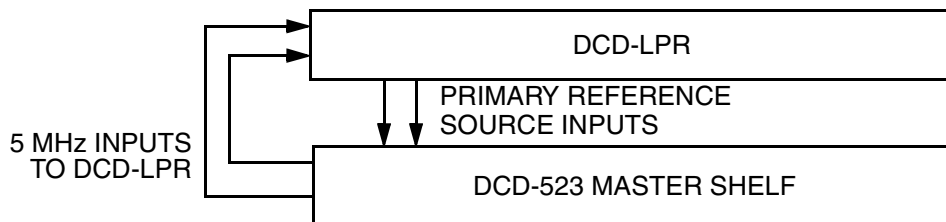

**Figure 7. DCD-523 to DCD-LPR Connection**

## F. Cards

**3.26** Table A lists the cards that may be installed in a DCD-523 System.

**3.27** Clock input cards are required in the DCD master shelf (in master and remote systems). Remote system master shelves should only be equipped with CI cards optioned for composite clock (CC) if the master shelf supplies timing via TOCA cards. Expansion shelves (in master and remote systems) do not require clock input or clock cards. A ribbon cable delivers system timing from the master shelf to each expansion shelf.

**3.28** In a master system master shelf, the following clock input card combinations may be installed:

- Two MRC cards
- Two CI-EA cards
- Two CI cards
- Two ACI cards
- Two DCIM cards
- One CI card and one ACI card

**3.29** Table B shows which output cards can be used in each protection mode unprotected (stand-alone), 1:1, 1+1, and 1:N.

**3.30** If a shelf does not require 1:N protection, the HS TO slots may be filled with unprotected one or two TO cards, SCIU/ESCIU cards, or a PSM card. Another interface panel must be installed to accommodate the extra outputs or inputs.

**3.31** All MI slots in a DCD System must be equipped with MIS cards of the same part number and software revision, or with SAI cards.

**3.32** Version 5 cards require an MIS<sup>V5</sup> card in the shelf to communicate data and manage the system. An expansion shelf with an MIS<sup>V5</sup> card requires an MIS<sup>V5</sup> card in the master shelf to communicate all synchronization and management data to the OSS. An MCA-5M card is required to manage Version 5 cards in 1:N protection.

**3.33** All slots in a shelf should be covered. If a shelf is not covered by a card, cover the slot with a blank plug-in card or a blank panel (Table C).

Table A. DCD-523 System Cards

CARD	PART NUMBER	DESCRIPTION	MASTER SHELF	EXPANSION SHELF
<b>CLOCK INPUT CARDS</b>				
ACI	090-41924-01	Analog Clock Input	X	—
CI	090-40010-01	Clock Input	X	—
CI -EA	090-41910-03	Clock Input, E1 or Analog	X	—
DCIM-EA <sup>V5</sup>	090-45010-59	Dual Clock Input Messaging, E1 or Analog (Note 2)	X	—
DCIM-T <sup>V5</sup>	090-45010-50	Dual Clock Input Messaging, T1 (Note 2)	X	—
MRC-EA	090-45010-06	Multiple Reference Controller, E1 and Analog (Note 2)	X	—
MRC-EA	090-45010-07	Multiple Reference Controller, E1 and Analog (Notes 2, 3)	X	—
MRC-EA <sup>V5</sup>	090-45010-56	Multiple Reference Controller, E1 and Analog (Note 2)	X	—
MRC-EA <sup>V5</sup>	090-45010-57	Multiple Reference Controller, E1 and Analog (Notes 2, 3)	X	—
MRC-T	090-45010-03	Multiple Reference Controller, T1 (Note 2)	X	—
MRC-T	090-45010-08	Multiple Reference Controller, T1 (Notes 2, 3)	X	—
MRC-T <sup>V5</sup>	090-45010-53	Multiple Reference Controller, T1 (Note 2)	X	—
MRC-T <sup>V5</sup>	090-45010-58	Multiple Reference Controller, T1 (Notes 2, 3)	X	—
<b>CLOCK CARDS</b>				
ST2E	090-40017-02	Enhanced Stratum-2 Clock	X	—
ST2	090-40017-01	Stratum-2 Clock	X	—
ST3E	090-40019-01	Enhanced Stratum-3 Clock (Maj/Min Alarm)	X	—
ST3E	090-40019-03	Enhanced Stratum-3 Clock (Maj Alarm)	X	—
ST3E	090-40019-11	Enhanced Stratum-3 Clock (Note 7)	X	—
ST3E	090-40019-13	Enhanced Stratum-3 Clock (Note 7)	X	—
ST3	090-40013-01	Stratum-3 Clock	X	—
TNC-E	090-40017-03	Enhanced Transit Node Clock	X	—

Table A. DCD-523 System Cards (Contd)

CARD	PART NUMBER	DESCRIPTION	MASTER SHELF	EXPANSION SHELF
<b>CLOCK CARDS (Contd)</b>				
TNC	090-40020-02	Transit Node Clock	X	—
LNC	090-40019-02	Local Node Clock	X	—
<b>TIMING OUTPUT AND INSERTION CARDS (Note 4)</b>				
EA10 <sup>V5</sup>	090-45029-52	Timing Output E1 and Analog	X	X
EA10M <sup>V5</sup>	090-45029-54	Timing Output E1 and Analog Messaging	X	X
TOAA	090-40022-xx	Timing Output Analog Automatic	X	X
TOAA	090-40028-10	Timing Output Analog Automatic	X	X
TOCA	090-40011-02	Timing Output Composite Clock Automatic	X	X
TOEA	090-40027-01	Timing Output E1 Automatic	X	X
TO-EA	090-40029-01	Timing Output E1 and Analog	X	X
TO-EA5 <sup>V5</sup>	090-45029-51	Timing Output E1 and Analog	X	X
TO-EAN <sup>V5</sup>	090-45029-56	Timing Output E1 and Analog, 1:N	X	X
TOGA	090-40022-07	Timing Output G.703 Automatic	X	X
TOLA	090-40023-xx	Timing Output Logic Level Automatic	X	X
TOTA	090-40012-02	Timing Output T1 Automatic	X	X
TOTA-5 <sup>V5</sup>	090-45012-52	Timing Output T1 Automatic (Note 5)	X	X
TOTA-M <sup>V5</sup>	090-45012-53	Timing Output T1 Automatic Messaging (Note 5)	X	X
TOTL	090-40012-03	Timing Output T1 with LBO	X	X
SCIU	090-40021-01	Synchronous Clock Insertion Unit	X	X
ESCIU	090-45021-01	E1 Synchronous Clock Insertion Unit	X	X
<b>MONITOR CARDS (Note 6)</b>				
PSM-E	090-45025-02	Precision Sync Monitor, E1	X	X
PSM-E <sup>V5</sup>	090-45025-52	Precision Sync Monitor, E1	X	X
PSM-EA <sup>V5</sup>	090-45025-54	Precision Sync Monitor, E1 and Analog	X	X

Table A. DCD-523 System Cards (Contd)

CARD	PART NUMBER	DESCRIPTION	MASTER SHELF	EXPANSION SHELF
<b>MONITOR CARDS (Note 6) (Contd)</b>				
PSM-T	090-45025-01	Precision Sync Monitor, T1	X	X
PSM-T <sup>V5</sup>	090-45025-51	Precision Sync Monitor, T1	X	X
PSM-T <sup>V5</sup>	090-45025-53	Precision Sync Monitor, T1	X	X
<b>ALARM/MAINTENANCE CARDS</b>				
MIS	090-45018-04	Maintenance Interface System (Note 8)	X	X
MIS	090-45018-14	Maintenance Interface System (Note 8)	X	X
MIS <sup>V5</sup>	090-45018-05	Maintenance Interface System (Note 8)	X	X
MIS <sup>V5</sup>	090-45018-25	Maintenance Interface System (Note 8)	X	X
MIS <sup>V5</sup>	090-45018-35	Maintenance Interface System (Note 8)	X	X
SAI	090-45014-02	System Alarm Interface	X	X
<b>PROTECTION MANAGEMENT CARD</b>				
MCA-5	090-45015-01	Matrix Controller Automatic-5	X	X
MCA-5M <sup>V5</sup>	090-45015-55	Matrix Controller Automatic-5 Messaging	X	X
<p>Notes:</p> <ol style="list-style-type: none"> <li>The <sup>V5</sup> indicates that this is a Version 5 card.</li> <li>If one of these cards is installed on a shelf, both cards in the same shelf must have the same part number.</li> <li>ITU G.812 Type 1 compliant.</li> <li>Some restrictions apply to TO cards when 1:N protection is used; Table D describes incompatibilities among TO cards.</li> <li>Some restrictions apply to TOTA cards when 1:N protection is used; Table E describes incompatibilities among TOTA cards.</li> <li>Do not install a 090-45025-01 PSM-T card in the same shelf with a 090-45025-52, -54, -51, or -53 PSM card.</li> <li>Holdover delay increased for SSM compatibility.</li> <li>See Part 5B, MIS Card, for compatibility with versions of the MIS card.</li> </ol>				

**Table B. Protection Modes for Output Cards**

Output Card	Stand-alone	1:1	1+1	1:N	MCA-5 (Note 1)				MCA-5M (Note 1)				SAI or MIS SW Version (Note 2)
					U	F	A	S	U	F	A	S	
EA-10	Y	Y	Y	N	—				—				5.02.xx
EA-10M	Y	Y	Y	N	—				—				5.04.xx
TOAA	Y	N	N	Y	Y	—	—	—	Y	—	—	—	SAI, any MIS
TOCA	Y	N	N	Y	Y	—	—	—	Y	—	—	—	SAI, any MIS
TOEA	Y	N	N	Y	Y	Y	—	—	Y	Y	—	—	SAI, any MIS
TO-EA	Y	N	Y	N	—				—				SAI, any MIS
TO-EA5	Y	Y	Y	N	—				—				5.02.xx
TO-EAN	Y	N	N	Y	N	N	N	—	Y	Y	Y	—	5.05.xx
TOGA	Y	N	Y	Y	Y	—	—	—	Y	—	—	—	SAI, any MIS
TOLA	Y	N	N	Y	Y	—	—	—	Y	—	—	—	SAI, any MIS
TOTA	Y	N	N	Y	Y	Y	—	—	Y	Y	—	—	SAI, any MIS
TOTA-5	Y	N	N	Y	Y	Y	N	—	Y	Y	Y	—	5.02.xx with MCA-5 (5.05.xx with MCA-5M)
TOTA-M	Y	N	N	Y	Y	Y	N	N	Y	Y	Y	Y	5.05.xx
TOTL	Y	N	N	Y	Y	—	—	—	Y	—	—	—	SAI, any MIS
SCIU	Y	N	N	N	—				—				SAI, any MIS
ESCIU	Y	N	N	N	—				—				SAI, any MIS

**Notes:**

- An MCA-5 or MCA-5M card is required in a shelf using 1:N protection. The type of MCA card affects the function of the output cards after a 1:N protection switch. The key for abbreviations in the headings of the columns are:  
 U: Use with card in 1:N protection  
 F: Frame alignment of HS card during 1:N protection switch  
 A: Alarm severity, Ports in service, Trouble codes transferred to HS card during 1:N protection switch  
 S: SSM codes transferred to HS card during 1:N protection switch
- The software version listed in the column, or a later version, must be installed in the MIS card in the shelf.
- The key for abbreviations in the body of the table:  
 Y: Function can be used  
 N: Function cannot be used  
 —: Not applicable
- The 090-40028-10 TOAA card cannot be used in 1:N protection.

**Table C. Slot Covers**

PART #	DESCRIPTION
090-45098-01	Single-slot blank plug-in card
970-00243-01	11-slot cover panel

**Table C. Slot Covers (Contd)**

PART #	DESCRIPTION
970-00243-02	8-slot cover panel
970-00014-02	3-slot cover panel

**Table D. 1:N TO Card Incompatibility**

**Table D. 1:N TO Card Incompatibility (Contd)**

<b>CARD IN HS SLOT</b>	<b>DO NOT INSTALL IN SHELF</b>
TOAA-02	TOAA-01, TOAA-03, TOLA-07
TOAA-03	TOAA-01, TOAA-02, TOLA-07
TOAA-05, TOAA-15	No restrictions
TOCA	TOLA-05
TOEA, TOGA, TO-EAN	No restrictions
TOLA-01	TOLA-02, TOLA-04
TOLA-02	TOLA-01, TOLA-04
TOLA-03	No restrictions
TOLA-04	TOLA-01, TOLA-02
TOLA-05	TOCA
TOLA-06	TOTA, TOTA-5, TOTL
TOLA-07	TOAA-01, TOAA-02, TOAA-03
TOTA, TOTA-5	TOTL, TOLA-06
TOTL	TOTA, TOTA-5, TOLA-06

**Table E. 1:N TOTA Card Compatibility with MCA-5M Card**

<b>TO CARDS INSTALLED IN SHELF</b>	<b>CARD REQUIRED IN AN HS SLOT</b>
TOTA-M	TOTA-M
TOTA-M & TOTA-5	TOTA-M
TOTA-M & TOTA	TOTA-M
TOTA-M & TOTA-5 & TOTA	TOTA-M
TOTA-5 & TOTA	TOTA-5 or TOTA-M
TOTA-5	TOTA-5 or TOTA-M
TOTA	TOTA or TOTA-5 or TOTA-M
<p>Note: The MCA-5 card can be used, but it transfers only the framing parameters when making a protection switch. The MCA-5M card transfers framing parameters, individual port configurations, trouble codes, alarm severity, and SSM codes.</p>	



**G. Interface Panels and Interface Modules**

**3.34** Connections between the DCD-523 System and external equipment are made at the wire-wrap panel, or at interface modules mounted onto a modular mounting panel (MMP).

**Interface Panels**

**3.35** An interface panel can be an ANSI-Class MMP (Figure 8), a wire-wrap panel (Figure 10), an ITU-Class MMP (Figure 11), or an ITU-Class Output MMP (Figure 9). A supplied ribbon cable carries signals between the connector position on the interface panel and the slot connector on the rear panel of the shelf.

**3.36** Each interface panel accommodates external connections for up to 10 cards. Each shelf comes equipped with an interface panel. If the number of external connections required exceeds the number of connections on

the interface panel, additional panels may be ordered; any combination of panels may be used.

**3.37** An MMP provides ten mountings for ten interface modules for various cable interfaces. Interface modules allow the appropriate connector to be used for each connection between the DCD Shelf and network elements.

**3.38** The remote wire-wrap panel (Figure 12) is designed to be mounted remotely in network element bays. It is cabled to the DCD Shelf wire-wrap panel using 25-pair ABAM cable with a 50-pin ISD connector, with a metal hood on the remote wire-wrap panel end. Each cable can transfer 20 DCD outputs to the remote panel location.

**Note:** It is recommended that no more than 40 outputs be transferred to a remote wire-wrap panel from any one shelf. If more than 40 outputs are required, install a remote system.

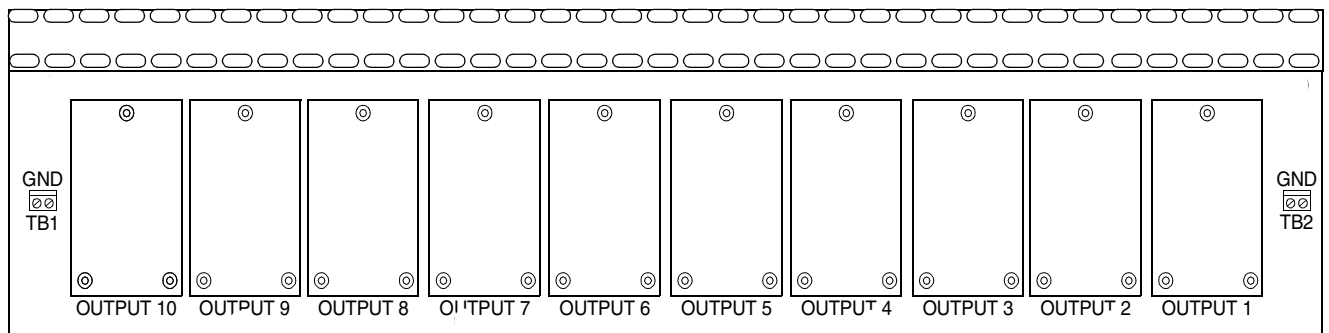

**Figure 8. ANSI-Class MMP**

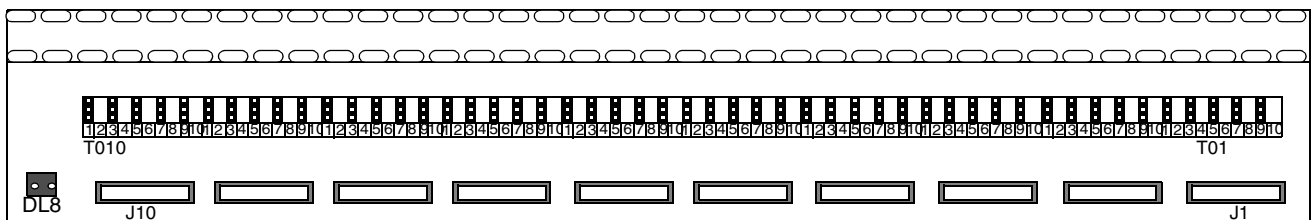

**Figure 9. Wire-wrap Panel**

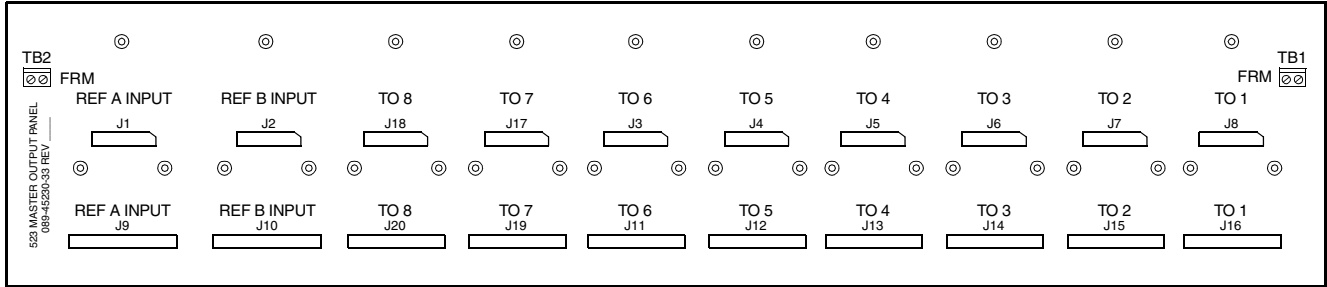

Figure 10. ITU-Class MMP

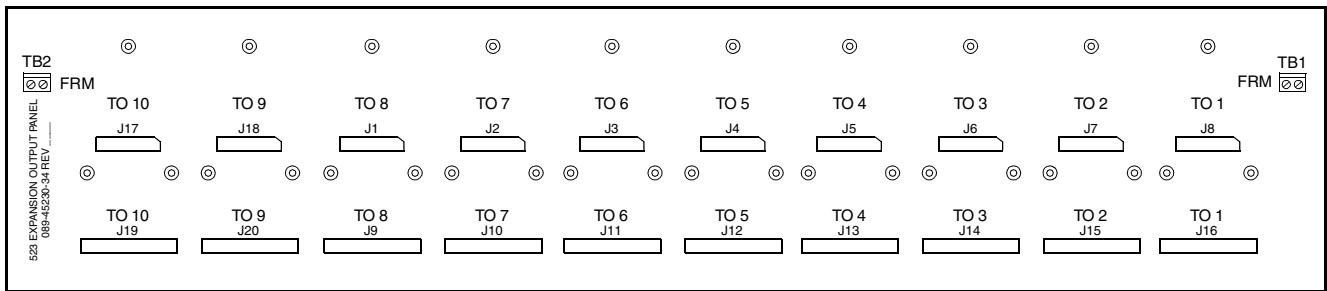

Figure 11. ITU-Class Output MMP

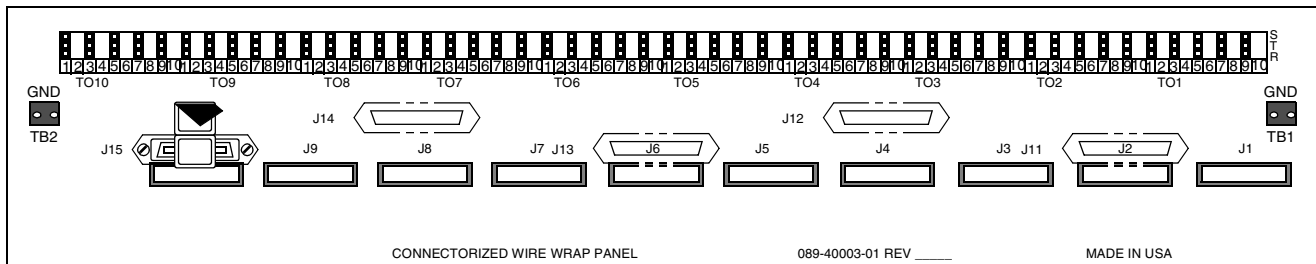

Figure 12. Remote Wire-wrap Panel

**Interface Modules**

**3.39** Interface modules connect to an MMP, so that input reference signals, timing output signals, and monitored signals may be connected to the cards in the shelf. Different modules contain different types of connectors, so the proper type of cable connector can be attached to the module.

**Note:** The 090-40028-10 TOAA card provides BNC connectors for its outputs on the front panel of the card, and does not require an interface module.

**3.40** Each reference input module contains a switch to tie the cable shield to frame ground. Tying the shield to ground is ordinarily not required, but may be used in noisy environments to reduce noise. Set the switch to FGND to tie the cable shield to frame ground, or OPEN to leave the cable shield open (floating).

**3.41** A module is associated with a slot in the shelf. A stand-alone card requires a single-wide output module. All redundant output card pairs require a double-wide output module to provide redundant-pair output protection. A PSM card, which occupies two TO slots, requires one single-wide module per card.

**H. Bridging Isolator Module**

**3.42** If bridged connections are required for E1 signals, a bridging isolator module (Figure 13 and

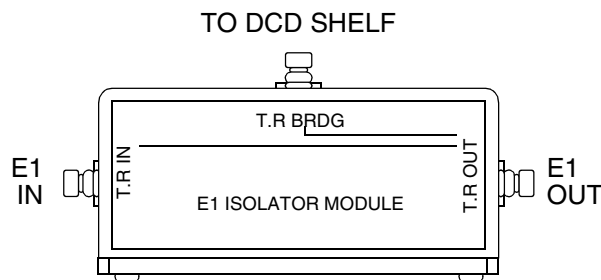

Note: The number and type of connectors change (one or three BNC, SMB, or Siemens 1.6/5.6) depending on the isolator module ordered.

**Figure 13. E1 Bridging Isolator Module**

Figure 14) must be used; these may be purchased from Symmetricom or an outside vendor. Symmetricom offers a variety of bridging isolator modules.

**3.43** The bridging isolator is installed in-line in a traffic-carrying CEPT/E1 bitstream. It provides no loss to the traffic-carrying E1 signal. It also provides one or three 750 Ω high-impedance bridged output connections which have a 20.8 dB (or 20 dB) isolation from the traffic signal. A bridged output connection may be used to drive a DCD Shelf input, or an input to a PSM card. The signal grounds are carried through the bridging isolator for both the traffic signal and the bridged signal.

**3.44** For additional information regarding the bridging isolation module, refer to the Installation section of this manual.

**I. Card Quantities**

**3.45** Table F lists the maximum number of cards of any single type that may be installed in a master or an expansion shelf.

**Caution:** Some restrictions apply when selecting TO and HS TO cards. If an HS TO card is not compatible with a TO card installed in either a TO or HS slot, incorrect protection switching could occur. Refer to for a list of incompatible HS TO and TO cards.

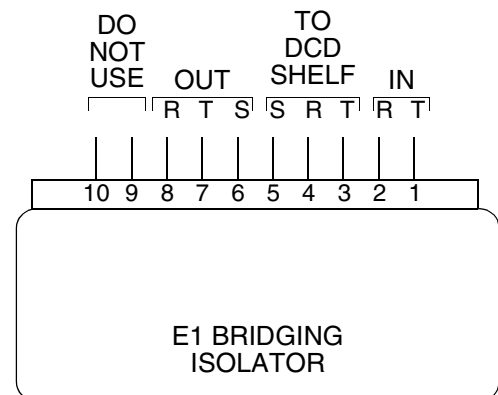

**Figure 14. Wire-wrap Bridging Isolator Module**

Table F. Card Quantities (Max. Number per Shelf)

CARD	MASTER SHELF		EXPANSION SHELF
	ST2E/ST2/TNC-E	ST3E/TNC/LNC	
Clock Input Cards (Note 1)	2	2	—
Clock Cards (ST2E, ST2,TNC-E) (Note 2)	2	—	—
Clock Cards (ST3E, ST3, TNC, LNC)	—	2	—
Timing Output (TO) (Notes 3 and 4)	Stand-alone (unprotected): 9 TO cards  Redundant protected: 4 pairs 1:N protected: 7 TO cards and 2 HS TO cards	Stand-alone (unprotected): 12 TO cards  Redundant protected: 6 pairs 1:N protected: 10 TO cards and 2 HS TO cards	Stand-alone (unprotected): 12 TO cards  Redundant protected: 6 pairs 1:N protected: 10 TO cards and 2 HS TO cards
HS TO	2	2	2
MIS or SAI (Note 5)	1	1	1
SCIU or ESCIU	9 unprotected	12 unprotected	12 unprotected
MCA-5 or MCA-5M	1 (only if 1:N output protection is required)		
PSM-E and PSM-T (Note 6)	2	2	5
PSM-E <sup>V5</sup> , PSM-EA <sup>V5</sup> , PSM-T <sup>V5</sup> (Note 6)	4	5	6

## Notes:

1. The MR A and MR B clock input slots are double-wide slots; if ACI cards (single-slot wide cards) are installed, install a blank card (p/n 090-45098-01) in the empty slot to the right of the ACI card.
2. The second ST2E, ST2, or TNC-E card physically occupies the TO1 through TO3 output slots, so these slots cannot be used for output, clock insertion, or monitor cards.
3. Some restrictions apply to TO cards when 1:N protection switching is used; see Tables D and E for TO card incompatibilities.
4. A TOTA-M card may be installed in the same shelf as a TOTA-5 card; however, there may be delays in SSM messaging.
5. If the master shelf is equipped with MIS cards, the expansion shelves must be equipped with MIS cards; the combination of MIS and SAI cards is not allowed.
6. A maximum of seven 090-45025-02 or -01 PSM cards are allowed in a single system (two in the master shelf and five throughout the expansion shelves, whether the system is a master or a remote system). The maximum number of 090-45025-52, -54, -51, or -53 PSM cards allowed in a single system is limited only to the number of available TO slots in the shelf. The shelf support bar does not allow installation of a PSM card into the TO3 slot.

## 4. SYSTEM DESCRIPTION

### A. System Architecture

**4.01** The system architecture (Figure 15) is based on four 4 kHz buses. This quad bus provides a highly redundant timing architecture. Each clock card and clock input card drives a separate bus. The output cards select the highest priority bus, and use that signal to develop a timing output in the proper frequency and format.

**4.02** The shelf contains an internal communications bus to administer shelf functions and communicate with an external reporting system.

**4.03** In multi-shelf systems, the master shelf develops the timing signals for the quad bus. Cables carry the quad bus to the expansion shelves. Each expansion shelf has its own internal communications bus for administering and reporting its own shelf functions.

### B. System Power

**4.04** The DCD-523 Systems are powered by two separate -48 V dc office battery inputs. Both -48 V dc inputs are fused on the shelf, then bused to each of the cards in the shelf. Input range is -42 V to -56 V. Each card contains a dc-to-dc converter to provide its own dc supply voltages.

### C. Input Signals

**4.05** Clock input cards accept input signals of various formats, and discipline the clock cards. Input signals are arranged in pairs and designated A (primary) and B (secondary) (see Figure 15). Input reference signals are typically:

- DS1 input reference signals, either 0 dB DSX (terminated) or -20 dB DSX (bridged).

- E1/2.048 MHz G.703 input reference signals, either 0 dB (terminated) or -20 dB (bridged).
- Analog input reference signals of 1 MHz, 2 MHz, 5 MHz, or 10 MHz.

**4.06** One or more input signals are applied to each clock input card, which drive the clock cards. The clock cards are phase-locked to the input signal and provide outputs to the TO cards.

**4.07** If multiple reference signals are desired, use MRC or DCIM cards. An MRC card accepts up to four reference input signals. The MRC card continuously monitors each of the provisioned reference inputs, checking for signal integrity, digital transmission errors, and frequency variations. A DCIM card accepts up to two reference input signals, and continuously monitors each of the provisioned reference inputs, checking for signal integrity and digital transmission errors.

**4.08** All DCD-523 clock input cards provide an internal 4 kHz clock locked to the input reference signal(s) to discipline the shelf clock cards. The 4 kHz clock signal also drives a line in the quad bus, to provide redundancy if a failure occurs in a clock card.

### D. Clocks

**4.09** The clock cards regenerate timing from the input signal and send it to timing output cards via the quad bus. A variety of clocks are available for installation in the DCD-523. These clocks, typically installed in pairs, provide independent, fully-redundant oscillators. The clocks installed determine the stability level available if the system must go into holdover.

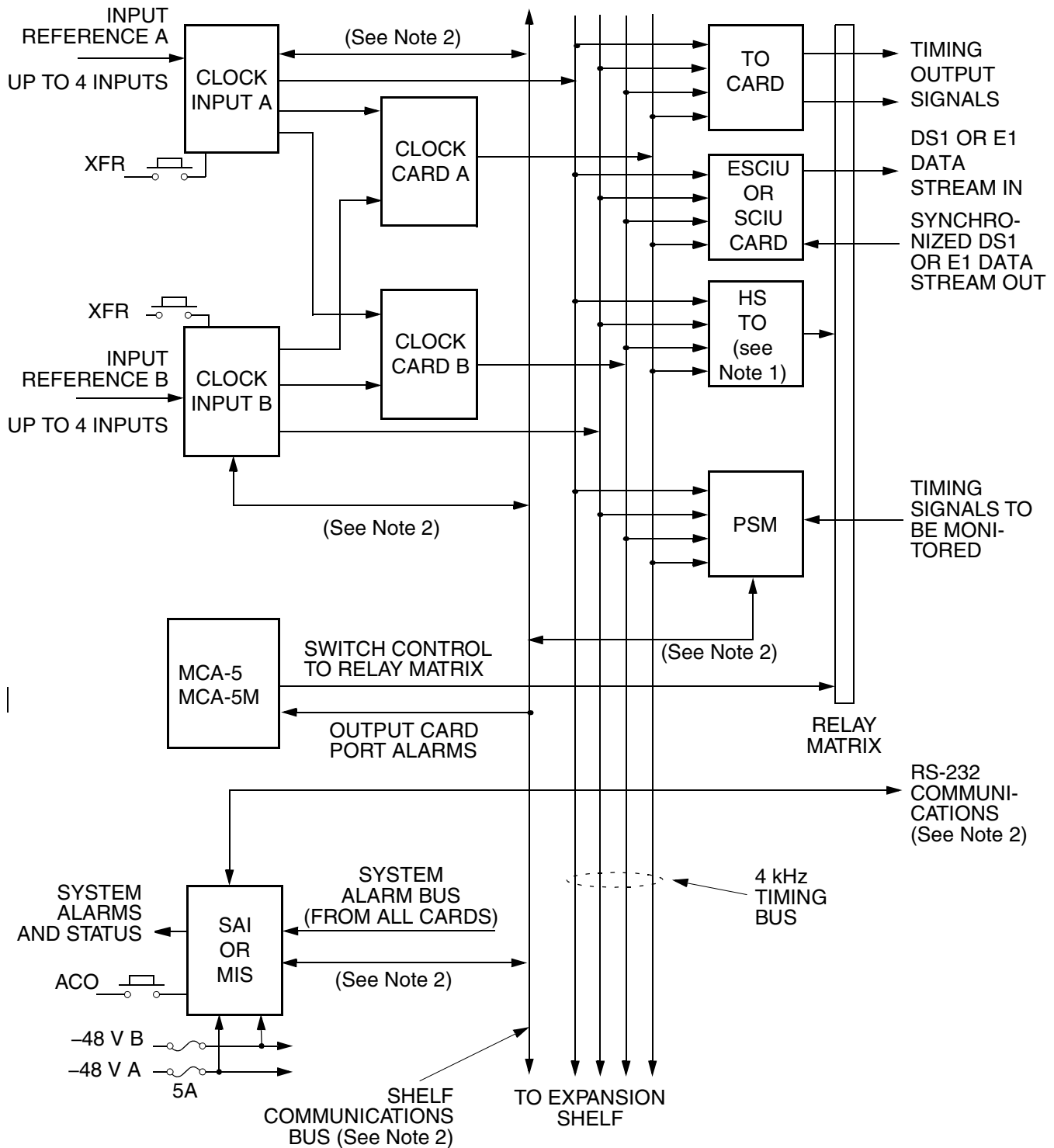

Notes:

1. Two HS TO cards may be equipped. However, only one TO may be placed in-service at a time.
2. This communications path is available only if the shelf is equipped with an MIS card.

Figure 15. DCD-523 System

**E. Reference Monitoring**

**4.10** A PSM card provides precision monitoring of up to four timing reference signals in real time. Detailed information on each reference is available from the MIS card, using an RS-232 connection and the TL1 language. Software from Symmetricom (available separately) provides a graphical user interface for TL1, graphing capabilities for the references monitored, and other functions, such as MTIE and TDEV.

**F. Timing Output**

**4.11** TO cards supply timing outputs formatted for use by equipment and facilities. The type of TO card installed determines whether the output signals are composite clock (CC), E1 or 2.048 MHz G.703, DS1, or logic level (RS-422, RS-423, RS-232). Timing outputs are constantly monitored for activity.

**4.12** TO cards monitor the internal quad timing bus for an input signal. A signal from a clock card has priority over a signal from a clock input card. Refer to Table G for input signal selection priority.

**Table G. Priority of Internal Timing Signals**

PRIORITY	CARD SUPPLYING TIMING
1	Clock A (ST A)
2	Clock B (ST B)
3	Clock Input A (CI A)
4	Clock Input B (CI B)

**4.13** If a higher priority signal is lost, TO cards switch to a lower priority signal. When any higher priority signal becomes available on the quad bus, most TO cards automatically revert to the higher priority source.

**4.14** The EA10, EA10M, TOTA-5, TOTA-M, TO-EA5, TO-EAN, and TO-EA cards need not revert automatically to the higher priority source. These cards can be set for revertive or nonrevertive switching of the quad bus sources. Nonrevertive switching reduces the possibility of hits caused by switching in-

put sources. When the card is configured for nonrevertive switching, the four sources on the internal bus are separated into the following individual groups:

- Clock source group
- Clock input source group

**4.15** In nonrevertive switching, a TO card does not revert to a higher priority source if that source is within the same group the TO card is using. The TO card only reverts to a source in the higher priority clock source group when the TO card is using a source from the clock input group.

**4.16** For example, a nonrevertive TO card is using the clock B signal because the clock A signal had been lost. When clock A is restored, the TO card remains using the clock B signal because it is in the clock source group. If the TO card had been using the clock input A signal when clock A is restored, the TO card reverts to the clock A signal, because it is in the higher priority clock source group.

**G. Output Protection**

**4.17** The DCD-523 System can be configured to provide protection for the timing outputs in the shelf. Card outputs may be protected in a 1:N, 1:1, or 1+1 protection plan, depending upon the cards installed and the shelf configuration.

**1:1 and 1+1 Protection**

**4.18** EA10, EA10M, TO-EA, TO-EA5, and TOGA card pairs can be used for protection of timing output signals. EA10, EA10M, and TO-EA5 cards can provide 1:1 or 1+1 protection; TO-EA and TOGA cards can only provide 1+1 protection. A double-wide output module is required for a 1:1 or 1+1 pair.

**4.19** In 1:1 protection, one card of the pair provides the active outputs and the other card's outputs are squelched. If the active card fails, the outputs of the other card become active, providing the output signal for the pair. In 1+1 protection, both cards produce output signals at a reduced power level. The signals are combined at the interface panel to create a normally powered output. If one card fails, the outputs of the other card are increased to normal power.

**Note:** When installing any redundant pair of TO cards in a shelf, install the pair in adjacent slots. Use slot pairs TO1 & TO2, TO3 & TO4, TO5 & TO6, TO7 & TO8, TO9 & TO10, or HS1 & HS2.

### 1:N Protection

**4.20** In 1:N protection, one card protects a number of cards in the same shelf. An MCA-5 or MCA-5M card is required for 1:N operation. All output card types can be part of a 1:N protection plan, except the TO-EA, TO-EA5, the EA series, ESCIU, SCIU, and 090-40028-10 TOAA cards. Certain cards are incompatible with each other in 1:N configurations (Tables D and E). The same single-wide output module that carries output signals for a standalone card carries output signals for a card in the 1:N configuration.

**4.21** All cards in a 1:N protection plan should be the same card type to provide protection for all card functions.

**4.22** The protection card is in an HS slot. Protected cards may be in any TO slot. Relays in the Output Protection Matrix select the signal from a TO slot or the signal from an HS slot to be sent to the output module. The Output Protection Matrix is controlled by the MCA-5 or MCA-5M card.

**4.23** If a signal from any TO card fails, the MCA card activates the relays that break the signal path from the TO card, and make the signal path from the HS card to the output connectors. The DCD-523 System with the hitless matrix (p/n 090-45230-03) makes the HS card signal path before breaking the TO card signal path.

**4.24** Only one HS TO card may be in service at a time. A second HS slot in the shelf permits protection for a second type of TO card.

**4.25** The MCA-5 card transfers some parameters (Table B) during a protection switch. All card types that support 1:N protection can be switched by the MCA-5 card.

**4.26** The MCA-5M card transfers all the applicable framing, alarm severities, trouble codes, ports in service, E1 and analog port configuration, and SSM information. The MCA-5M card fully supports the TO-EAN and TOTA-M cards. Table B provides further information.

**4.27** After a protection switch, the push button above the alarmed TO card can identify the failed ports. When the push button is pressed, lamps on the front of the MCA card identify the failed TO card ports.

### 1:N Automatic Protection Switching

**4.28** The MCA card identifies a failed TO card and automatically performs the protection switch. The failed card can be replaced at a convenient time. The HS card remains the active output card until a higher level failure occurs, or until an operator initiates a switch.

**4.29** If the HS card reports the same port alarms as the original card, the failure is assumed to be external to the TO card and the outputs switch back to the original TO card. The original card is not allowed to switch again until the current minor alarm clears, or until a major or critical alarm is declared. If output cards are set for nonrevertive switching, the HS card remains the active output card until a higher level failure occurs, or until an operator initiates a switch.

### 1:N Manual Protection Switching

**4.30** A manual 1:N switch can be initiated by pressing the appropriate push buttons on the DCD front panel, by issuing a TL1 command to an MCA-5M card, or by inserting a pin in cards equipped with disabling jacks. The HS card remains the active output card until an operator initiates a switch.

**4.31** The front panel of many output cards contains disabling jacks to disable each of its ports. If a disabling pin is inserted into one of the disabling jacks, the port is disabled and a port alarm is registered. The port alarm initiates a protection switch.

### H. Synchronous Clock Insertion

**4.32** Synchronous clock insertion synchronizes an incoming or outgoing data-carrying facility with the DCD timing source. The data stream enters the DCD System, becomes synchronized to DCD timing in the SCIU or ESCIU card, and leaves the DCD System.

**4.33** Since data is carried on these timing lines, the interface panel for connecting the data lines contains a by-pass relay that closes if the card fails, allowing data to pass through the system during an alarm condition.



**I. SSM**

**4.34** The DCIM-EA, DCIM-T, EA10M, and TOTA-M cards can receive, process, and generate Synchronization Status Message (SSM) messages. A Version 5.04 or higher MIS card is required to handle SSM messages inside the system.

**4.35** To communicate with an MIS card, the DCIM-EA, DCIM-T, and EA10M cards require a Version 5.04 or higher MIS card in the shelf.

**4.36** If EA10M cards are in redundant-pair protection and processing SSM messages, both cards in the pair must be the EA10M card type.

**4.37** The MCA-5M card, which is required for 1:N protection in a managed Version 5 shelf, can process SSM messages. This card requires a Version 5.05.01 or higher MIS card.

**4.38** An operator can assign an SSM quality level to any clock input card or clock card via TL1 commands, whether that card can process SSM messages or not.

**4.39** One SSM message set is specific to E1, and another set is specific to T1. A single shelf can support E1 SSM messaging, or T1 SSM messaging, but not both.

**4.40** Table H lists valid SSM clock input card combinations; Table I lists invalid SSM clock input card combinations.

**Table H. Valid SSM Clock Input Card Combinations**

Slot 1	Slot 2
DCIM-EA	DCIM-EA or no card
DCIM-EA or no card	DCIM-EA
DCIM-T	DCIM-T or no card
DCIM-T or no card	DCIM-T
MRC-EA	MRC-EA or no card
MRC-EA or no card	MRC-EA
MRC-T	MRC-T or no card
MRC-T or no card	MRC-T
Note: The DCIM cards can process SSM messages. Other clock input cards must be assigned a quality level by TL1 command.	

**Table I. Invalid SSM Clock Input Card Combinations**

Slot 1	Slot 2
MRC-EA	MRC-T
MRC-T	MRC-EA
Any DCIM card	Any MRC card
Any MRC card	Any DCIM card
Any non-Version 5 clock input card	Any non-Version 5 clock input card
Any DCIM card	CI, ACI, or CI-EA card
CI, ACI, or CI-EA card	Any DCIM card

**4.41** The following are valid card types for T1 SSM operation:

- DCIM-T
- TOTA-M
- MRC-T, CI, or ACI (if installed according to Tables H and I)

**4.42** The following cards are valid card types for T1 E1 SSM operation:

- DCIM-EA
- EA10M
- MRC-EA, CI, ACI, or CI-EA (if installed according to Tables H and I)

**5. ALARM AND MAINTENANCE CARD DESCRIPTIONS**

**A. SAI Card**

**5.01** The SAI card provides DCD alarm summary with office and remote telemetry alarm relay closures and status indicators, and may be used in place of the MIS card if remote RS-232 communication to the shelf is not required.

**5.02** The SAI card may be used for both master and expansion shelf configurations to provide major and minor alarm reporting. (Power supply alarms are not passed from the expansion to the master shelf.) In systems configured with a non-standard MIS card in the master shelf, either an SAI or MIS card can be installed in an expansion shelf to report alarms to the MIS card in the master shelf.

**5.03** Output alarms from the TO cards, input reference alarms from the clock input cards, and fail alarms from any card in the shelf are sent to the SAI card on the shelf alarm bus. Status indications, including clock loss and port alarms, are also monitored by the SAI card. Depending on which alarms are received, the SAI activates audible and visual alarm and status indicator (SI) outputs. An additional set of status leads on the backplane enables either a major or minor alarm in the event of the failure of a battery or a blown fuse.

**Note:** Major and minor alarm leads have both normally open (NO) and normally closed (NC) dry relay contacts. Major and Minor Status Indicators have NO relay contacts only. All other status indicators are open-collector outputs between the SI lead and battery return (SR). No voltage potential exists on the SI leads, therefore they can be used to interface external systems with negative voltages such as -48 V dc and -24 V dc.

**5.04** When dc power is lost to the shelf, the normally open relays close, initiating an office alarm.

**5.05** A front-panel ACO push button, when pressed, silences the audible alarm and lights the ACO lamp. The ACO push buttons on all shelves in the system have the same effect. An external lead on the shelf backplane is provided for remote ACO operation.

## B. MIS Card

**5.06** An MIS card installed in the master shelf provides office and remote telemetry surveillance and control for the DCD-523 System. The MIS provides DCD alarm summary with office and remote telemetry alarm relay closures and status indicators, as well as remote RS-232 communication to the system via TL1. The MIS card is installed in the far right side slot (MI) of the DCD-523 master or expansion shelf.

**5.07** Two versions of the MIS card are available, 090-45018-04 and 090-45018-14 (non-Version 5 MIS) and 090-45018-05 (MIS<sup>V5</sup>). Cards that cannot be used in the

same shelf as an MIS<sup>V5</sup> card are listed in Table J. Cards that cannot be used in the same shelf as a non-Version 5 MIS card are listed in Table K.

**5.08** MIS<sup>V5</sup> card communications support both hardware flow control (via the CTS and RTS pins of the RS-232 cable) and software flow control (via the XON/XOFF protocol), and use commands compatible with X.25-based PAD interfaces and the Hayes modem command set.

**5.09** A database of information for the DCD System can be downloaded from the remote communications device held in nonvolatile RAM, if the proper card switch is selected. The previous copy of the database, if it exists, remains in effect until cleared.

**Table J. Cards Incompatible with MIS<sup>V5</sup>**

CARD	PART NUMBER
MCA5	090-45015-01 (Rev. E or earlier)
GTI (Note 2)	090-42140-11
GTI (Note 2)	090-42140-12
GTI (Note 2)	090-42140-13 (Rev. D or earlier)
GTI (Note 2)	090-42140-14 (Rev. D or earlier)
GTI (Note 2)	090-42140-15 (Rev. A)
MRC-EA	090-45010-06
MRC-EA	090-45010-07
MRC-T	090-45010-03
MRC-T	090-45010-08
PSM-E	090-45025-02
PSM-T	090-45025-01
SAI	090-45014-02
Notes:	
1. Install an MIS <sup>V5</sup> card in any shelf that contains a Version 5 card.	
2. This card may not be installed in an LPR System that is used with a DCD-523 System that has an MIS <sup>V5</sup> card in its master shelf.	

**Table K. Cards Incompatible with Non-Version 5 MIS**

CARD	PART NUMBER
GTI (Note 2)	090-42140-13 (Rev. E or later)
GTI (Note 2)	090-42140-14 (Rev. E or later)
GTI (Note 2)	090-42140-15 (Rev. B or later)
GTI (Note 2)	090-42140-16
MRC-EA <sup>V5</sup>	090-45010-56
MRC-EA <sup>V5</sup>	090-45010-57
MRC-T <sup>V5</sup>	090-45010-53
MRC-T <sup>V5</sup>	090-45010-58
MRC-T <sup>V5</sup>	090-45010-54
TO-EA5 <sup>V5</sup>	090-45029-51
TO-EAN <sup>V5</sup>	090-45029-56
TOTA-5 <sup>V5</sup>	090-45012-52
PSM-E <sup>V5</sup>	090-45025-52
PSM-EA <sup>V5</sup>	090-45025-54
PSM-T <sup>V5</sup>	090-45025-51 or 090-45025-53
EA10 <sup>V5</sup>	090-45029-52
EA10M <sup>V5</sup>	090-45029-54
<b>Notes:</b> 1. To conduct communications external to the DCD System, an MIS must be installed in the master shelf. An SAI card may be used in place of an MIS card in expansion shelves. 2. This card may not be installed in a DCD-LPR System that is used with a DCD-523 System that has an MIS card in its master shelf.	

**5.10** An MIS<sup>V5</sup> card installed in a shelf allows TL1 commands to configure cards and retrieve data from individual Version 5 cards in the shelf. If a card in the shelf is replaced with a card of the same type, the MIS<sup>V5</sup> card sets the replacement card to the same configuration as the replaced card. If an MIS<sup>V5</sup> card replacement does not have a shelf database in nonvolatile memory, the re-

placement card populates its database with data from the shelf. If a replacement card has a database, the replacement card configures the shelf according to its database.

**5.11** An MIS<sup>V5</sup> card in the master shelf communicates with and configures the entire DCD System via MIS<sup>V5</sup> cards in the expansion shelves. An MIS<sup>V5</sup> card must be installed in each expansion shelf that contains a Version 5 card. Each MIS<sup>V5</sup> card in an expansion shelf configures the cards and retrieves the data for its shelf, and exchanges information with the MIS<sup>V5</sup> card in the master shelf.

**5.12** The non-Version 5 MIS card allows TL1 commands to retrieve alarm information and certain status from the system. A non-Version 5 MIS card must be installed in the master shelf, and an SAI or non-Version 5 MIS card must be installed in each expansion shelf in the system from which alarm information is desired.

**5.13** The various commands used to communicate with an MIS card are defined in the TL1 User's Guide (provided with each MIS card).

**5.14** Output alarms from the TO cards, input reference alarms from the clock input cards, and fail alarms from any card in the shelf are sent to the MIS card on the shelf alarm bus. Status indications, including clock loss and port alarms, are also monitored by the MIS card.

**5.15** The MIS card activates audible and visual alarms, and status indicator (SI) outputs according to the alarms received. An additional set of status leads on the backplane enables either a major, minor, or critical alarm in the event of a battery failure or a blown fuse.

**Note:** Major, minor, and critical alarm leads have both normally open (NO) and normally closed (NC) dry relay contacts. Major, Minor, and Critical Status Indicators have NO relay contacts only. All other status indicators are open-collector outputs between the SI lead and battery return (SR) lead. No voltage potential exists on the SI leads, therefore they can be used to interface external systems with negative voltages such as -48 V dc and -24 V dc.

**5.16** Alarm battery supply is not required for the system. When dc power is lost to the shelf, the NO relays close, initiating an office alarm.

**5.17** A front-panel ACO push button, when pressed, silences the audible alarm and lights the ACO lamp. The ACO push buttons on all shelves in the system have the same effect. An external lead on the shelf backplane is provided for remote ACO operation.

**5.18** The MIS card in the master shelf communicates with an Operations Support System (OSS) for the entire DCD-523 System. Version 5 cards in an expansion shelf must communicate with an MIS<sup>V5</sup> located in the same expansion shelf. The MIS card has three RS-232 ports (COM1, COM2, and COM3) and an 8-pin RJ45 connector (LOCAL COMM) on the faceplate.

**Note:** The COM2 and LOCAL COMM connectors carry the same information at the same settings from the same communications port on the MIS card. One or the other may be active, but not both simultaneously. On non-Version 5 MIS cards, COM3 is an input port only. It does not provide autonomous alarm reports; it only provides response messages to input commands that are directed to that port.

**5.19** The MIS reports alarms (via autonomous messages) to the OSS in real time, and writes both alarms and events to a log. The log stores up to 256 messages (MIS<sup>V5</sup>) or 64 messages (non-Version 5 MIS) and is accessed via TL1 language commands. Alarms are categorized by software as major, minor, and critical. Events are categorized as not alarmed or not reported.

**5.20** The status of the shelf is available at the front panel lamps. A MAJOR, MINOR, or CRITICAL lamp lights to indicate that one of those alarms exists on the shelf. The FAIL lamp lights to indicate that the MIS card has failed. The ACO lamp lights when the ACO push button is pressed to silence an audible alarm before the alarm is cleared.

**5.21** The MIS card includes a security feature that prevents unauthorized users from accessing TL1 commands. The security feature can be enabled and disabled by using a switch on the MIS card. When the switch is set to disable security, any user can access all TL1 commands; the user does not need a password to log on to the system and access commands.

**5.22** When the switch is set to enable security, users must use a password to log on to the system and access commands. All TL1 commands are assigned an

access level. When the security feature is enabled, the command access levels are enabled. Each authorized user is also assigned an access level. The user's access level allows that user to access only those commands that are at that level and below. Refer to the TL1 User's Guide (provided with each MIS card) for more information about the MIS security feature.

## SSM Processing

**5.23** MIS cards with software version 5.04 or higher have SSM processing capability. SSM operation is enabled by TL1 command via the MIS card. Refer to the TL1 User's Guide (provided with the MIS software) for more information on enabling SSM operation.

**5.24** The MIS card manages the DCIM card references for SSM operation. Through TL1 command, the MIS card provisions ports for SSM, sets the SSM interaction hold-off threshold time, sets DCIM SSM port priority, and enables pseudo SSM operation for non-Version 5 clock input cards, MRC cards, or digital or analog inputs not supporting SSM. Refer to the TL1 User's Guide for more information on MIS SSM operation through TL1 commands.

## 6. CLOCK INPUT CARD DESCRIPTIONS

### A. CI-EA Card

**6.01** Each CI-EA card uses a single E1 or analog (defined as G.703) input (2.048 Mb/s for E1 or 2.048 MHz for analog) as its timing reference. The reference signal connects to the CI-EA card via a reference input module on the interface panel. Option switches on the card allow user-selection of the framing type of the input signal, and the input signal type as either digital E1 or analog. The PLXO produces an internal timing signal that is bused to the clock reference cards and the TO cards in the DCD-523 System.

**6.02** The CI-EA card contains a control circuit that causes a switch to the redundant CI-EA if the active card fails. Input signal outages, PLL unlocks, excessive code violations, or loss of sync cause the system to switch CI-EA cards.

**6.03** During normal operation with a rubidium clock, each clock is locked to its respective CI-EA card (A or B). If a CI-EA card fails or is degraded, the source clock automatically switches to the other

CI-EA card which supplies both clocks until the failed reference is restored. If both CI-EA cards fail, the clocks will go into holdover mode.

**6.04** During normal operation with a quartz clock, the source to the active clock is derived from either CI-EA card. In a normally operating, fully equipped shelf, the CI-EA card that was installed first is the source for the clock. If the source CI-EA card fails, the quartz clock uses the signal from the other CI-EA card. If both CI-EA cards fail, the clocks will go into holdover mode.

**6.05** On quartz clock systems, transfer between CI-EA cards can be manually initiated by pressing the front-panel XFR switch on either CI-EA card.

**6.06** On rubidium clock systems, clock A is locked to clock input A and clock B is locked to clock input B, therefore, switching between clock input cards is not possible. The ST2/ST3 switch on the backplane determines whether the CI-EA cards operate in the rubidium clock mode or the quartz clock mode.

## B. CI Card

**6.07** Two CI cards provide input signal redundancy. Each CI card uses one CC or one DS1 input as its timing reference. A switch on the CI card selects the type of input and the framing format (if DS1) of the input timing signal. Front panel lamps (CC and DS1) show which type of input is present.

**Note:** The CC input from an existing office clock is used for Stratum-3 applications only; ST2E, TNC-E, ST2, ST3E, TNC, or LNC clock cards *must not* be fed with CC input.

**6.08** The DS1 input can be either a terminated signal or a low-level (bridged) signal via the built-in bridging amplifier. Refer to the Installation section of this manual for recommended bridging connections.

**6.09** Under normal operating conditions, CI A drives clock card A, and CI B drives clock card B. Both input reference signals are simultaneously monitored, and if an input fails, the clock card automatically switches to the other CI card, which then supplies both clock cards until the failed reference is restored. The SOURCE ACTIVE lamp on the front panel indicates which CI card is active.

**Note:** Both CI cards are active if the system is configured with redundant ST2E, ST2, or TNC-E cards (operating in ST2 mode). Only one CI card is active in systems with ST3E, TNC, or LNC cards. This is determined by the ST2/ST3 switch on the backplane.

**6.10** The CI card contains a source control circuit that causes the card to switch to the redundant CI card if the primary card (defined as the card currently in operation) fails.

**6.11** On quartz clock systems, transfer between CI cards can be manually initiated by pressing the front-panel XFR switch on either CI card. The switch function is also available for remote control.

**6.12** On rubidium clock systems, clock A is locked to clock input A and clock B is locked to clock input B, therefore, switching between clock input cards is not possible. The ST2/ST3 switch on the backplane determines whether the CI cards operate in the rubidium clock mode or the quartz clock mode.

**6.13** If both CI cards fail, the clock cards go into holdover mode, and the system automatically uses the active clock card.

## C. ACI Card

**6.14** The ACI card performs the same functions as the CI card, except its input reference signal is analog instead of digital. The ACI card accepts analog inputs of 1 MHz, 2 MHz, 5 MHz, or 10 MHz. A frequency control circuit reads the frequency-select switches, lights the appropriate front-panel lamp (1 MHz, 2 MHz, 5 MHz, or 10 MHz), and sends a frequency-control signal to the clock recovery circuit.

**6.15** If input signal problems continue, the ACI initiates a transfer to the other ACI card. The SRC ACT lamp lights on the active card (the one supplying timing). If the other card also cannot supply timing, the clocks go into holdover.

**6.16** On quartz clock systems, transfer between ACI cards can be manually initiated by pressing the front-panel XFR switch on either ACI card.

**6.17** On rubidium clock systems, clock A is locked to clock input A and clock B is locked to clock input B, therefore, switching between clock input cards is not

possible. The ST2/ST3 switch on the backplane determines whether the ACI cards operate in the rubidium clock mode or the quartz clock mode.

#### D. DCIM Cards

**6.18** The DCIM cards include the DCIM-EA and DCIM-T cards. Each DCIM card has connections for two external reference source inputs.

**6.19** A VCXO produces an internal timing signal which is locked to the active input reference. The 4 kHz reference is derived from the VCXO, which is bused to the clock and TO cards in the DCD-523 System.

**6.20** DCIM-EA cards accept either 2.048 Mb/s E1 or 2.048 MHz analog signals; DCIM-T cards accept 1.544 Mb/s DS1 signals. The inputs can be either with or without SSM.

**6.21** A switch on the DCIM card selects the type of input and the framing format of the input timing signal on a per port basis.

**6.22** The user can program the framing format, using the MIS interface and TL1 commands. Refer to the TL1 User's Guide for information regarding these commands.

**6.23** Each input can be either a terminated signal or a low-level (bridged) signal via the built-in bridging amplifier. Refer to the Installation section of this manual for recommended bridging connections.

**6.24** The FAIL lamp on the DCIM card lights red to indicate that the card failed.

**6.25** There is a separate front-panel REF lamp for each reference source, and each lamp indicates the status of the corresponding reference input. The REF lamps light green when an input is enabled and has passed error check. The REF lamps light red when an input is enabled and fails the error check (high CRC, OOF, BPV, AIS, or LOS). The REF lamps do not light if the associated input is not enabled.

**6.26** There is a separate front-panel STAT lamp associated with each input reference. Green indicates the input is providing a reference signal to the VCXO.

#### Performance Monitoring of Digital Parameters

**6.27** The DCIM card scans each enabled input to monitor transmission and performance parameters.

Each input is sampled every second. Spans that are not enabled are not checked. Scanning continues to cycle through the active inputs while the card is powered.

**6.28** The DCIM reports an event when the transmission event count exceeds the assigned threshold. The factory-set thresholds are as follows:

- Alarm indication signal (AIS): 1
- Bipolar violations (BPV): 16
- Cyclic Redundancy Check (CRC): 16
- Loss of signal (LOS): 1
- Out of frame (OOF): 1

**6.29** The OOF and AIS counts represent the number of errored seconds for each event during the time the DCIM scans the input. The BPV and CRC counts represent the actual number of errors counted while the input is being scanned. All thresholds except LOS are user-configurable, and the report given when a threshold is exceeded can be changed from a condition to an alarm.

**6.30** The monitored parameters and calculated values are stored in ninety-six 15 minute bins. The bins are first-in, first-out (FIFO) so that when the 97th interval is completed, the oldest stored 15 minute data is overwritten. The data in these bins is the 1 minute averaged raw phase values. Therefore, a 15 minute bin will contain 15 data points.

**6.31** Performance data is collected only for inputs that have been enabled by card switches or TL1 command. If the DCIM card is removed from the shelf, all error counts and stability measurement data registers are set to zero.

#### Non-SSM Operation

##### *1 + 1 Mode*

**6.32** In this mode, the two DCIM cards function as a single card with four inputs. Only one of the four inputs is used to provide a reference for the shelf. Therefore, only one DCIM card is active at a time.

**6.33** Priorities can be assigned to the four inputs in any order, or all inputs can be assigned the same priority, or any combination thereof (1 is the highest priority).

**6.34** If the same priority is assigned to multiple inputs (where no other inputs have a higher priority), the first signal to be qualified is used. If this signal fails, another input with the same priority is used. If the disqualified signal is requalified, the system does not switch back to the requalified signal because the requalified signal has the same priority. This is the nonrevertive feature.

**6.35** If different priorities are assigned to the inputs, the highest priority signal is used. If the highest priority signal fails, the next-highest priority signal is used. If the disqualified signal is requalified, the system reverts to the requalified signal. This is the revertive feature.

### **Stand-alone Mode**

**6.36** In this mode, each DCIM card operates as a single card with two inputs. Each card uses the input with the highest priority. If the ST2/ST3 switch is in the ST2 position, each DCIM card supplies a reference signal to the corresponding clock card.

**6.37** If one of the DCIM cards fails or both of the inputs on a card are disqualified, the remaining DCIM card provides a reference to both clock cards.

**6.38** If the ST2/ST3 switch is in the ST3 position, one of the DCIM cards is used (active) at a time with that DCIM card supplying both clock cards. The active card can be changed by pressing the XFR push button switch on either DCIM card front panel.

**6.39** The inputs can operate in revertive or nonrevertive mode, depending on priorities assigned.

### **SSM Operation**

**6.40** If two DCIM cards are installed, up to four inputs are available. However, only one DCIM card is active at a time. The input with the highest SSM quality level signal is always used. If multiple signals have the same highest SSM quality level, the input with the highest priority is used.

**6.41** If multiple inputs have the same highest SSM quality level, and the same priority, and if the active signal is disqualified or reduces its SSM quality level, another signal with the same highest quality level is used. If the signal is requalified, or returns to its original quality level, the system does not switch back to the requalified signal (nonrevertive).

**6.42** The following can be achieved through TL1 commands (refer to the TL1 User's Guide for information regarding these commands):

- Provision ports for digital operation with a specific framing option
- Provision ports supporting and not supporting SSM
- Set the wait-to-restore delay
- Set the SSM interaction hold-off threshold time
- Set the SSM port priority when more than one port is active
- Retrieve the current SSM message on particular ports on a specific DCIM card
- Switch active port status on a port with a lower-quality value, and also release the forced condition
- Enable pseudo SSM operation and assign quality levels to non-Version 5 clock input cards, MRC cards, or digital or analog inputs not supporting SSM

### **E. MRC Cards**

**6.43** The MRC cards include the MRC-EA, MRC-T, MRC-EA<sup>V5</sup>, and MRC-T<sup>V5</sup> cards. Each MRC card has connections for four external reference source inputs, and contains two internal uncorrected reference sources to use as a timing reference source. The MRC-EA cards can be switch-selectable to accept either 2.048 Mb/s E1 or 2.048 MHz analog signals; the MRC-T cards accept 1.544 Mb/s DS1 signals. Framing on MRC-T inputs can be set manually or to automatically detect the framing type.

**6.44** An MRC card communicates with the MIS card to configure the input port priority, and report status and alarm information to the MIS card.

**6.45** An MRC<sup>V5</sup> card works with an MIS<sup>V5</sup> card to configure input port priority, report status and alarm information, and enable and disable status and alarm reporting to the MIS<sup>V5</sup> card. Additional status and alarm information is provided with the MRC<sup>V5</sup> card. This card provides status of the 4 kHz reference clock and an MIS communication loss alarm.

**6.46** In the automatic framing mode, the MRC-T card automatically recognizes the incoming D4 or ESF framing and automatically locks to the incoming framing if it is either of these formats.

**6.47** If the incoming framing pattern changes, the MRC-T card automatically recognizes the new framing format. During this framing period, the MRC-T card declares excessive OOF errors on the input until the MRC-T card can lock to the framing format, at which time it will declare the input good by lighting the front-panel REF lamp green for that input.

**6.48** The user may program the framing format, using the MIS interface and TL1 commands. Refer to the TL1 User's Guide for information regarding these commands.

**6.49** Through internal connections, the MRC card also uses the free-running oscillator in the clock cards (TNC-E, ST2E, and ST2) as references in the majority vote. In total, the MRC card continuously measures and utilizes six signals (four external plus two internal).

**6.50** Under normal operating conditions, each MRC card simultaneously acts as a time scale generator and reference monitor. With at least three usable references available (and at least two are independent), the MRC card performs a majority vote, and determines whether a reference is acceptable.

**6.51** References considered "usable" (for majority vote) are those inputs (external and internal) whose REF lamp is lit green. References considered independent for majority vote are network, cesium, or backfed rubidium signals from the ST2E, ST2, or TNC-E oscillator.

**6.52** Majority vote begins with the MRC card continuously scanning all of its active internal (backfed ST signals) and external references. While scanning the references, the MRC card gathers raw phase data and calculates the average frequency for each active reference. A matrix of usable references, versus all references, is created and a pair-wise comparison is made between all valid combinations of inputs. From this matrix, an average frequency difference is calculated for each pair. This difference is used to disqualify individual references. Each input has been given a threshold value based on its input type. These values are: GPS, LORAN-C, cesium at  $5 \times 10^{-10}$ , rubidium at  $2 \times 10^{-9}$ , and network at  $1 \times 10^{-8}$ .

**6.53** In the process of calculating the frequency difference for each pair, the threshold for disqualification is the sum of the individual input thresholds. For example, when comparing rubidium to cesium, the threshold for the pair is  $5 \times 10^{-10} + 2 \times 10^{-9} = 2.5 \times 10^{-9}$ . If a system is equipped with MRC and ST2E/TNC-E cards, and has multiple network feeds into each MRC card, the MRC card will disqualify a network feed if the frequency offset is greater than allowed. Each pass of the majority vote algorithm takes approximately 30 seconds. It takes up to approximately 60 seconds to confirm that the input is out of tolerance.

**6.54** If the conditions for majority vote are not met (e.g., insufficient inputs), and there is still a "usable" external reference available, the MRC card will revert to "CI" mode. In this mode, the MRC card locks to the highest priority input that is declared good, and operates similar to the CI card (for information regarding CI card operation, refer to Part 5B, CI Card). However, under this condition, the MRC card does not perform majority vote. If a reference fails due to excessive errors, LOS, etc., while in this mode, the MRC card will automatically switch to the next available highest priority input. The output signal is maintained, regardless of its "quality."

**6.55** If all external references have been voted out, the MRC card will also revert to "CI" mode and continue to use the highest priority input. The MRC card will continue to monitor the inputs to requalify those that begin meeting the frequency offset thresholds.

**6.56** Two sets of switches are available on the MRC card to set the following parameters:

- Whether the references (1 through 4) are disabled or enabled
- The input type and priority level. Setting the reference type also determines the input priority. References are treated with the following priority:
  - a. GPS (priority level 1)
  - b. LORAN (priority level 2)
  - c. Cesium (priority level 3)
  - d. Network (priority level 4)



**Note:** Priorities should not be set by setting “incorrect” input types, that is, for Network to be priority 1, it cannot be identified as GPS; attempting to redefine input priority by changing its type, via card switches, will cause a malfunction of the MRC card. However, this priority scheme may be changed via TL1 commands issued through the MIS card.

**6.57** If the same reference type is designated for more than one input, the input number decides the priority level. For example, if inputs 2 and 3 are both designated GPS, input 2 would have higher priority. This priority scheme may be changed via TL1 commands issued through the MIS card.

**6.58** When the MRC card is power cycled, it will revert to its switch settings unless an MIS card is present in the shelf. The MIS card stores all option data for the MRC card. If an MRC card is replaced or power cycled with an MIS card present in the shelf, the MIS card will download the previously stored MRC card options for that slot. To configure the MRC card to revert to the switch settings, instead of to previously stored options, remove the MIS card from the shelf before inserting the MRC card. Once the MRC card test has been completed, reseal the MIS card. This will cause the MRC card to upload its switch settings as the current configuration.

**6.59** The MRC card performs hitless switching between inputs if the clock cards are present and the signal is good. If the active input to an MRC card fails, it will automatically switch to the next highest priority input that is declared good. When the failed input is declared good, the MRC card will automatically switch back to it to keep the input priorities in order.

**6.60** The FAIL lamp on the MRC card lights red to indicate that the MRC power supply has failed, or diagnostic self-tests have failed.

**6.61** Front panel REF input lamps indicate reference input stability; green indicates the input is enabled and good, red indicates input has failed due to LOS or excessive error counts, and no lamp indicates the input has not been enabled.

**6.62** Front panel STATUS input lamps indicate the reference stability state; green indicates the input has been selected as the reference, yellow indicates input is over stability threshold, and no lamp indicates the input is within stability threshold for its reference type. A flashing green and yellow STATUS

lamp indicates that the MRC card has disqualified its last “usable” reference due to majority vote, but is continuing to use that reference for its output.

**6.63** If due to excessive errors or LOS, all four inputs fail to the active MRC card, an automatic switch occurs to the other MRC card, which then supplies both clock cards with a clock signal until the failed reference(s) is restored. The SRC ACTIVE lamp on the front panel indicates which MRC card is active.

**Note:** Both MRC cards are active if the system is configured with at least one ST2E, ST2, or TNC-E card. Only one MRC card is active in systems with ST3E, TNC, or LNC cards (MRC card may not be used with ST3 clock cards). The different modes are determined by the ST2/ST3 switch on the backplane. When the shelf is equipped with 090-45010-08, -54, and -57 MRC cards, the ST2/ST3 switch must be in the ST2 position.

**6.64** The MRC card performs a sampled error check on all provisioned inputs to monitor error parameters for: LOS, OOF, CRC, AIS, and BPV. Once completed, error checking on the next enabled span begins. This procedure is repeated until all references to the MRC card are monitored, and then starts over on the first input.

**6.65** If high error counts exceeding thresholds are found, the reference is declared unacceptable, and the MRC card switches to the next highest priority input that is acceptable.

**6.66** Each MRC card is shipped with factory-set thresholds for each digital error parameter; the factory settings are:

- Out of frame (OOF): 4
- Alarm indication signal (AIS): 4
- Bipolar violations (BPV): 16
- Cyclic redundancy check (CRC): 16
- Loss of signal (LOS): 1

**6.67** OOF and AIS counts represent the number of errored seconds for each event while scanning the inputs. BPV and CRC counts represent the actual number of errors counted for each event while scanning the inputs. LOS is an actual count of loss-of-signal events.

An event is defined as a transition from signal to LOS. All thresholds, except for LOS, may be user-configured to meet specific network requirements via the MIS card and TL1 commands.

**6.68** If both MRC cards fail, the clock cards go into holdover mode, and the system automatically uses the active clock to provide timing to the output cards.

**6.69** If the ST2/ST3 switch on the backplane is in the ST3 position, transfer between MRC cards can be manually initiated by pressing the front-panel XFR switch on either MRC card.

**6.70** If the ST2/ST3 switch on the backplane is in the ST2 position, the XFR switch does not function.

**Note:** Each MRC card takes approximately 45 minutes after power-up to complete oscillator characterization. During this warm-up period, it is possible to receive errant fractional frequency disqualification messages for either the clock card or external inputs, or both. All other MRC card functions operate normally. After the 45 minute warm-up period, the MRC card begins normal operation. If fractional frequency disqualification messages are then listed, the MRC cards respond as appropriate.

If a clock card is reseated or installed for the first time after the MRC card has completed the warm-up period, the MRC card resets its 45 minute counter for the oscillator in question.

## 7. CLOCK CARD DESCRIPTIONS

### A. ST2E Card

**7.01** The ST2E clock card provides a stable reference to drive the TO cards. The essential element of the ST2E card is a rubidium atomic oscillator with a 24 hour holdover stability that exceeds most required specifications. The oscillator is calibrated over a wide temperature range to provide additional stability during ambient temperature variations.

**7.02** ST2E cards are normally configured to function as a pair. The ST2E A card receives its reference from clock input A, and the ST2E B card receives its reference from clock input B.

**7.03** During normal operation, each ST2E card is locked to its respective clock input card (A or B). A reference signal generated by the clock input cards is passed to the clock cards via the backplane bus. The clock then samples and averages the reference input and updates a control register. During this process, the values are adjusted for the current temperature. Network wander filtering is achieved by this process, in combination with microprocessor filtering.

**7.04** Each ST2E card monitors the frequency of the other ST2E card's output signal and compares it to the clock input card signals. If an out-of-range level is detected, the ST2E card identifies whether the reference is drifting with respect to the ST2E clock.

**Note:** The ST2E card remains active and tracks the respective input. If a problem is detected on the output, the SRC A or SRC B lamp, depending on which card has the problem, will function as follows:

- If the ST2E card is tracking the output of the clock input card, the lamp lights green.
- If the reference from the clock input card is disqualified (clock signal is out of tolerance), the lamp lights red.
- If the reference from the clock input card is missing, the lamp goes off.
- If the reference from the clock input card is drifting (drift exceeds  $1 \times 10^{-9}$  within 5 minutes), the lamp flashes green.

**7.05** The ST2E card provides extensive fault tolerance and diagnostic utilities provided by the rubidium control system working with the DCD Shelf. The ST2E card also has the capability to inter-work with Symmetricom's DCD-LPR System to provide PRS performance.

**7.06** The TR-1244 control loop ensures that all rearrangement activity of the clock input cards or the ST2E cards is performed without hits on the internal reference bus. If an input reference signal fails to meet ST2E card input tolerance requirements, the secondary source will be selected. This action will not result in a phase movement at the output. Finally, if all available reference signal inputs are not within the pull-in range, the ST2E card enters its holdover state.

**Note:** TR-1244 is a Telcordia standard defining DCD clock filtering and performance requirements for high performance networks such as SONET or SDH.

**7.07** When the ST2E card enters holdover, the 24 previous 1 hour averages are retrieved from a data history file. Any single 1 hour average that is out of tolerance is discarded and the remaining are averaged with the current temperature value to establish a holdover value for the synthesizer.

**7.08** The output of the ST2E card is controlled by a frequency synthesizer. Any frequency difference between the ST2E card and the reference generates a change in the synthesizer frequency that moves the output toward a frequency difference of zero. If all reference outputs are precisely matched, no correction is given to the synthesizer.

**Note:** None of the frequency and phase comparisons are made with only one ST2E card installed.

**7.09** The OSC lamp flashes green if the card requires factory maintenance (flashes for approximately 2 weeks—after which, the card fails and the output is disabled). The OSC lamp lights red if the oscillator has failed (disables the ST2E card output). To avoid the failure mode, replace the card when the OSC lamp flashes green. Normal mode is indicated when the OSC lamp is off.

**7.10** All status lamps on the ST2E card front panel are duplicated as ALARM status leads on the shelf backplane. A switch option on the shelf backplane is provided to enable either major or minor alarm status when both ST2E card clocks are in holdover mode.

**7.11** With both input cards installed, each ST2E card indicates an active status. In addition, each ST2E card indicates that it is using one of the two possible inputs by lighting the respective SRC A or SRC B lamp. The output cards select the ST2E card in the ST A slot as the preferred clock. The ST2E card in the ST B slot becomes the preferred clock only if one of the following conditions occur:

- a. The ST2E card in the ST A slot fails.
- b. The ST2E card in the ST A slot is removed.

- c. The DSBL push button switch on the ST2E card faceplate in the ST A slot is pressed (this switch is hidden by the CAUTION label, and may be pressed only if the card is going to be removed—once the switch is pressed, the output is disabled for up to 20 minutes).

**Note:** The DSBL push button on the ST2E card installed in the ST B slot does not function (the card in the ST B slot cannot be disabled).

**7.12** The outputs from both ST2E cards and both clock input cards are available to the timing output cards for selection based on preset priorities (refer to Table G for priorities).

## B. ST2 Card

**7.13** The ST2 clock card provides a stable reference to drive the TO cards. ST2 cards are normally configured to function as a pair. ST2 A receives its reference from clock input A and ST2 B receives its reference from clock input B.

**7.14** During normal operation, each ST2 card is locked to its respective clock input card (A or B). A 4 kHz reference signal generated by the clock input cards is sampled for 5 minutes and averaged. At the end of the 5 minute period, a new averaged value is given to the synthesizer. This 5 minute value is combined with the 12 previous 5 minute samples and adjusted for the current temperature. Network wander filtering is achieved by this process, in combination with microprocessor filtering.

**7.15** The output of the ST2 card is controlled by a 17-bit frequency synthesizer. Any frequency difference between the ST2 card and the reference generates a change in the synthesizer frequency that moves the output towards a frequency difference of zero. If all reference outputs are precisely 4 kHz, no correction is given to the synthesizer.

**7.16** The key to the performance of the ST2 card is a compact rubidium atomic oscillator physics package. The rubidium oscillator is temperature compensated to ensure a stable output. The frequency synthesizer that regulates the output signal is matched to the oscillator performance to guarantee there is sufficient dynamic range to accommodate temperature and aging variations over the expected life of the ST2 card.

**7.17** Each ST2 card monitors the frequency of the other ST2 card's 4 kHz signal and compares it to the clock input signals. If an out-of-range level is detected, the ST2 cards initiate an "inputs unlocked" status. This merely means that the respective input signals to each ST2 card have drifted apart from one another. This is not a service-affecting phenomenon. Note, however, the ST2 card remains active and tracks the respective input.

**7.18** If problems are detected in the ST2 card, the ST2 card initiates a transfer to remove the bad card from the DCD System. All transfers, clock input and ST2 cards, are performed without hits on the internal 4 kHz reference bus by transferring the phase information to the backup card. If an input reference signal fails to meet ST2 card input tolerance requirements, the secondary source is selected. This action will result in a phase movement at the output, according to ANSI and Telcordia specifications. Finally, if all available reference signal inputs are not within the Stratum-2 pull-in range, the ST2 card enters into holdover.

**7.19** When the ST2 card enters holdover, the 36 previous 1 hour averages are retrieved from a history file in RAM. The most recent 12 are discarded and the remaining 24 are averaged with the current temperature value to establish a holdover center frequency value for the synthesizer.

**7.20** If, for any reason, the processor detects that maintenance is required on the ST2 card, the REF lamp flashes (depending upon which reference the ST2 card is locked to, REF A or REF B). A minor alarm is issued. The alarm may be retired by pressing the XFR front-panel push button. The REF lamp continues to flash, indicating that maintenance is required.

**7.21** While the maintenance (REF) lamp is flashing, the ST2 card clock continues to operate normally. However, after 180 days or more, the ST2 card may go into failure mode, in which case it is taken off line, the FAIL lamp lights, and a major alarm is generated. The active status transfers to the other clock in the system.

**7.22** None of the frequency and phase comparisons or transfers are made with only one ST2 card. The "inputs unlocked" lamp is inoperative. The transfer switch, in this case, transfers the clock input reference rather than the active ST2 card when operating as a pair.

**7.23** All status lamps on the ST2 card front panel are duplicated as ALARM status leads on the shelf backplane. A switch option on the shelf backplane is provided to enable either major or minor alarm status when both ST2 card clocks are in holdover mode.

### C. ST3E Card

**7.24** The ST3E clock card provides a stable reference to drive the TO cards. During normal operation, the input to the ST3E card is derived from clock input card A or clock input card B. In a normally operating, fully equipped shelf, the ST3E card uses the signal from the clock input card that was installed first. If the card in the MR A slot fails or is not equipped, the ST3E card uses the signal from the card in the MR B slot. The input reference (REF) may be manually switched by pressing the transfer (XFR) push button on either clock input card.

**7.25** The output stays locked to the reference input as long as the following conditions exist:

- Input reference signal is within the pull-in range.
- The maximum frequency step of the input reference signal is less than the input tolerance.
- The rate of change (slope) of the input reference is less than the input tolerance.

**7.26** The internal synthesizer contains a frequency adjustment range to accommodate temperature and aging variations over the service lifetime of the card. Changes to the synthesizer are in frequency steps, which allows the synthesizer to act as an "electronic flywheel" and buffer the phase and frequency changes of the input.

**7.27** If the input reference signals are either unavailable or out of range, the ST3E card will change state and enter a holdover mode. The last 24 hours of input frequency samples are stored, averaged, and continuously updated. The synthesizer uses this value, which is known to be good, as the clock center frequency. When the input signals are restored and lock is achieved, the ST3E card exits holdover mode.

**7.28** Fault tolerance is achieved in the DCD Shelf by using redundant clock input signals (via paired clock input cards) and redundant ST3E cards. If one of the clock input cards or reference signals fails, the ST3E card automatically switches to the signal from the other clock input card.

**7.29** The outputs from both ST3E cards, and both clock input cards, are available to the TO cards for selection based on preset priorities (refer to Table G for priorities).

#### D. ST3 Card

**7.30** The ST3 clock card provides timing signals at Stratum-3 accuracy to the main bus to drive the TO cards. Select logic on each TO card automatically chooses the input timing signal of the highest priority (refer to Table G). Since the ST3 is the only clock card capable of accepting and tracking a composite clock (CC) input signal, it is primarily deployed in remote shelf systems within an office; it may be configured alone or in pairs.

**7.31** The ST3 card is based on phase-locked loop (PLL) filtering and VCXO technology. The ST3 card is a relatively wide bandwidth fast-tracking clock that provides the necessary jitter attenuations and holdover stability. The PLL output is compared to a temperature-compensated oscillator (TCXO) and an offset is generated to phase-lock to the clock input (A or B).

**7.32** If an input source is unavailable or has failed, the circuit goes into clock holdover mode at the frequency of the last valid input. The ST3 then provides clocking to the TO cards for a minimum of 24 hours. If the DCD-523 System is started without an input reference, the ST3 maintains accuracy at a predetermined rate.

**7.33** The output timing signal is placed on a common bus for use by all TO cards in the system. If both ST3 cards fail, a major system alarm is issued and the TO cards use the output of the clock input cards.

**7.34** A phase buildout circuit between the two clock input (A and B) cards and each ST3 clock prevents transients from being transmitted to the TO cards when there is a transfer between the two ST3 cards.

#### E. TNC-E Card

**7.35** The TNC-E clock card provides a stable reference to drive the TO cards. The essential element of the TNC-E card is a rubidium atomic oscillator with a 24 hour holdover stability that exceeds most required specifications. The oscillator is calibrated over a wide temperature range to provide additional stability during ambient temperature variations.

**7.36** TNC-E cards are normally configured to function as a pair. The TNC-E A card receives its reference from clock input A, and the TNC-E B card receives its reference from clock input B.

**7.37** During normal operation, each TNC-E card is locked to its respective clock input card (A or B). A reference signal generated by the clock input cards is passed to the clock cards via the backplane bus. The clock then samples and averages the reference input and updates a control register. During this process, the values are adjusted for the current temperature. Network wander filtering is achieved by this process, in combination with microprocessor filtering.

**7.38** Each TNC-E card monitors the frequency of the other TNC-E card's output signal and compares it to the clock input card signals. If an out-of-range level is detected, the TNC-E card identifies whether the reference is drifting with respect to the TNC-E clock.

**Note:** The TNC-E card remains active and tracks the respective input. If a problem is detected on the output, the SRC A or SRC B lamp, depending on which card has the problem, will function as follows:

- If the TNC-E card is tracking the output of the clock input card, the lamp lights green.
- If the reference from the clock input card is disqualified (clock signal is out of tolerance), the lamp lights red.
- If the reference from the clock input card is missing, the lamp goes off.
- If the reference from the clock input card is drifting (drift exceeds  $1 \times 10^{-9}$  within 5 minutes), the lamp flashes green.

**7.39** The TNC-E card provides extensive fault tolerance and diagnostic utilities provided by the rubidium control system working with the DCD Shelf. The TNC-E also has the capability to inter-work with Symmetricom's DCD-LPR System, to provide PRS performance.

**7.40** The TR-1244 control loop ensures that all rearrangement activity of the clock input cards or the TNC-E cards is performed without hits on the internal reference bus. If an input reference signal fails to meet TNC-E card input tolerance requirements, the

secondary source will be selected. This action will not result in a phase movement at the output. Finally, if all available reference signal inputs are not within the pull-in range, the TNC-E card enters its holdover state.

**Note:** TR-1244 is a Telcordia standard defining DCD clock filtering and performance requirements for high performance networks such as SONET or SDH.

**7.41** When the TNC-E card enters holdover, the 24 previous 1 hour averages are retrieved from a data history file. Any single 1 hour average that is out of tolerance is discarded and the remaining are averaged with the current temperature value to establish a holdover value for the synthesizer.

**7.42** The output of the TNC-E card is controlled by a frequency synthesizer. Any frequency difference between the TNC-E card and the reference generates a change in the synthesizer frequency that moves the output toward a frequency difference of zero. If all reference outputs are precisely matched, no correction is given to the synthesizer.

**Note:** None of the frequency and phase comparisons are made with only one TNC-E card installed.

**7.43** The OSC lamp flashes green if the card requires factory maintenance (flashes for approximately 2 weeks—after which, the card fails and the output is disabled). The OSC lamp lights red if the oscillator has failed (disables the TNC-E output). To avoid the failure mode, replace the card when the OSC lamp flashes green. Normal mode is indicated when the OSC lamp is off.

**7.44** All status lamps on the TNC-E card front panel are duplicated as ALARM status leads on the shelf backplane. A switch option on the shelf backplane is provided to enable either major or minor alarm status when both TNC-E card clocks are in holdover mode.

**7.45** With both input cards installed, each TNC-E card indicates an active status. In addition, each TNC-E card indicates that it is using one of the two possible inputs by lighting the respective SRC A or SRC B lamp. The output cards select the TNC-E card in the ST A slot as the preferred clock. The TNC-E card in the ST B slot becomes the preferred clock only if one of the following conditions occur:

- a. The TNC-E card in the ST A slot fails.
- b. The TNC-E card in the ST A slot is removed.
- c. The DSBL push button switch on the TNC-E card faceplate in the ST A slot is pressed (this switch is hidden by the CAUTION label, and may be pressed only if the card is going to be removed—once the switch is pressed, the output is disabled for up to 20 minutes).

**Note:** The DSBL push button on the TNC-E card installed in the ST B slot does not function (the card in the ST B slot cannot be disabled).

**7.46** The outputs from both TNC-E cards and both clock input cards are available to the timing output cards for selection based on preset priorities (refer to Table G for priorities).

## F. TNC Card

**7.47** The TNC card provides a stable reference to drive the TO cards. TNC cards are normally configured to function as a pair.

**7.48** During normal operation, both TNC cards are locked to one clock input card (A or B). A reference signal generated by the clock input card is passed to the clock cards via the backplane bus. The clock then samples and averages the reference input and updates a control register. Network wander filtering is achieved by this process, in combination with micro-processor filtering.

**7.49** The output of the TNC card is controlled by a numerically controlled oscillator (NCO). Any frequency difference between the TNC card and the reference generates a change in the oscillator frequency that moves the output toward a frequency difference of zero. If all reference outputs are precisely matched, no correction is given to the NCO.

**7.50** If problems are detected in the TNC card, the TNC card initiates a transfer to remove the bad card from the DCD System. All transfers, clock input and TNC cards, are performed without hits on the internal reference bus by transferring the phase information to the backup card. If an input reference signal fails to meet TNC card input tolerance requirements, the secondary source will be selected. This action results in a phase movement within standards

at the output. Finally, if all available reference signal inputs are not within the TNC card pull-in range, the TNC card enters holdover mode.

**7.51** When the TNC card enters holdover mode, the 24 previous 1 hour averages are retrieved from a data history file. Any single 1 hour average that is out of tolerance is discarded and the remaining are averaged with the current temperature value to establish a holdover value for the synthesizer.

**7.52** If, for any reason, the processor detects that maintenance is required on the TNC card, the REF lamp flashes (depending upon which reference the TNC card is locked to—REF A or REF B). To avoid a card failure, replace the card when the REF lamp flashes.

**7.53** All status lamps on the TNC card front panel are duplicated as ALARM status leads on the shelf backplane. A switch option on the shelf backplane is provided to enable either major or minor alarm status when both TNC clocks are in holdover mode.

## G. LNC Card

**7.54** The LNC card provides a stable reference to drive the TO cards. During normal operation, the local node clock is derived from clock input card A or clock input card B. In a normally operating, fully equipped shelf, the LNC card uses the signal from the clock input card that was installed first. If the card in the MR A slot fails or is not equipped, the LNC card uses the signal from the card in the MR B slot. The input reference (REF) may be manually switched by pressing the transfer (XFR) push button on either clock input card.

**7.55** If the input reference is within the pull-in range of the LNC card, any phase or frequency difference between the input reference and the center frequency of the LNC card's internal oscillator is reduced to zero and locked to the reference signal using feedback.

**7.56** The LNC card output is taken from the clock synthesizer which produces a common reference timing signal on the shelf backplane. The output stays locked to either reference input as long as the following conditions exist:

- Input reference signal is within the pull-in range.
- Maximum frequency step of the input reference signal is less than the input tolerance.

- Rate of change (slope) of the input reference is less than the input tolerance.

**7.57** The synthesizer was built with a frequency adjustment range to accommodate temperature and aging variations over the service lifetime of the card. Changes to the synthesizer are in frequency steps, which allows the synthesizer to act as an “electronic flywheel” and buffer the phase and frequency changes of the input.

**7.58** If the input reference signals are either unavailable or out of range, the LNC card will change state and enter a holdover mode. The last 24 hours of input frequency samples are stored, averaged, and continuously updated. The synthesizer uses this value, which is known to be good, as the clock center frequency. When the input signals are restored and lock is achieved, the LNC card exits the holdover mode.

**7.59** Fault tolerance is achieved in the DCD Shelf by using redundant clock input signals (via paired clock input cards) and redundant LNC cards. If one of the clock input cards or reference signals fails, the LNC card automatically switches to the signal from the other clock input card.

**7.60** The outputs from both LNC cards and both clock input cards are available to the TO cards for selection based on preset priorities.

## 8. TIMING OUTPUT CARD DESCRIPTIONS

### A. EA10 Card

**8.01** The EA10 card provides 10 E1 output signals with framing, or 10 analog output signals at 2.048 MHz. Each output can be set to digital or analog signals independently by TL1 commands, or in groups of five outputs by switch settings. The EA10 card can be used as a stand-alone output card, or can be paired with an adjacent EA10 card to provide redundant-pair (1:1 or 1+1) outputs.

**Note:** Do not use an EA10 card in a 1:N protection mode.

**8.02** EA10 cards communicate with an MIS<sup>V5</sup> card, which provides full messaging, status reporting, and configuration control.

## Stand-alone Configuration

**8.03** The card obtains the timing signal from the DCD internal timing bus (clock card A, clock card B, clock input A or clock input B), according to the priority in Table G. If no input timing signals are present, the EA10 card turns off its ST and INP lamps, lights the FAIL lamp, and squelches the outputs.

**8.04** Framing format (CAS or CCS with or without CRC4) is set by card switches or TL1 commands. Front panel lamps indicate the selected framing format for each card.

**8.05** Switches or TL1 commands select the timing signal type (E1 or analog). The E1 or analog timing signal is applied to each port driver and sent through an impedance-matching transformer to the output connector.

**8.06** A switch or TL1 commands set the port alarm severity to minor or major for the card. An alarm on any port generates the alarm selected. A port alarm is detected only for the failure of the port hardware on the card.

**8.07** A switch or TL1 commands sets the card for revertive or nonrevertive switching of the input timing signals. When the card is configured for nonrevertive switching, the four sources on the internal bus are separated into the following groups:

- Clock source group (ST A and ST B)
- Clock input source group (CI A and CI B)

**8.08** In nonrevertive mode, the EA10 card minimizes input reference switching by not reverting to a previous reference source within the same group. For example, the EA10 card switches to the ST B reference if ST A fails. The EA10 card does not revert to ST A when ST A is restored, because the EA10 card is using a signal in the clock source group. The reference switches to CI A if both ST A and ST B fail. If the EA10 card is using the CI A reference and one of the sources in the clock group is restored, the EA10 card reverts to the highest available source (ST A or ST B) in the clock source group.

**8.09** When the EA10 card is configured for revertive switching, the highest available source is always used (refer to Table G for a prioritized list of the input timing signals). If any source fails, the EA10

card switches its reference to the source that is next in priority. If any higher priority source is restored, the EA10 card switches its reference to that source.

## 1:1 Output Protection Configuration

**8.10** A 1:1 pair must be installed in one of the following slot pairs: TO1&TO2, TO3&TO4, TO5&TO6, TO7&TO8, TO9&TO10, or HS1&HS2. A double-wide output module must be installed on the interface panel. If the paired cards are configured to communicate with an MIS card, switch settings and TL1 parameters for both cards in the pair must be identical. If the paired cards are not configured to communicate with an MIS card, only the switch settings for both cards in the pair must be identical. Both cards in the pair must be using the same input reference from the internal DCD timing bus. A pair of EA10 cards provides ten timing outputs. Each EA10 card in the pair performs all the functions of the EA10 card in a stand-alone configuration, plus communication with the other card in the pair and with the MIS<sup>V5</sup> card.

**8.11** In a 1:1 pair, one card is active and the other card squelches its outputs. If the active card fails, the mate becomes the active card, minimizing disruption to the timing outputs.

**8.12** The EA10 card in the odd-numbered slot of the pair checks for a card in the even-numbered slot. If a card exists, the card in the odd-numbered slot checks for compatible hardware and software revisions, and checks for identical operating parameters, including port output settings. The card in the even-numbered slot checks for a compatible card in the odd-numbered slot. The card in the odd slot becomes the active card of the pair.

**8.13** When the internal EA10 card checks have been completed, a switch setting determines whether timing outputs are immediately enabled, or whether TL1 commands enable the outputs.

**8.14** If either EA10 card finds that its mate is not compatible or does not exist, the EA10 card will not become active until the user intervenes. If the EA10 card is configured to communicate with an MIS card, the MIS card sends an error message. The EA10 card resumes functioning after the user sends appropriate commands, or if a compatible card is installed in the other slot.

**8.15** Both cards in the pair can be configured to communicate configuration, status, and alarm information to a MIS<sup>V5</sup> card in the shelf.



## 1+1 Output Protection Configuration

**8.16** A 1+1 redundant pair must be installed in one of the following slot pairs: TO1&TO2, TO3&TO4, TO5&TO6, TO7&TO8, TO9&TO10, or HS1&HS2. Switch settings and TL1 parameters for both cards in the pair must be identical if the cards are configured to communicate with an MIS card. If the cards are not configured to communicate with an MIS card, only the switch settings for both cards must be identical. Both cards in the pair must be using the same input reference from the internal DCD timing bus. A double-wide output module must be installed on the I/O panel.

**8.17** In a 1+1 pair, the timing signals from each card are attenuated so that the combined output at the interface module is the correct power level. Each EA10 card in the 1+1 pair performs all the functions of a card in a stand-alone configuration, plus communication with the other card in the pair and with the MIS<sup>V5</sup> card. Each pair of EA10 cards provides ten timing outputs.

**8.18** If a card fails, the outputs of that card are squelched and the mate increases the power on its outputs, minimizing disruption to the timing outputs.

**8.19** Power-up and fault detection actions are the same as for the 1:1 card pair.

### B. EA10M Card

**8.20** The EA10M card functions the same as the EA10 card, plus it is SSM capable. SSMs are transmitted continuously until there is a state change initiated by the MIS. Also, the user can assign output messages by TL1 command.

### C. TOAA Card

**8.21** The TOAA card outputs two sine wave outputs with selectable frequencies at various voltage levels and impedances. Six different TOAA cards are available (090-40022-01, -02, -03, -05, -15, and 090-40028-10).

**8.22** The TOAA 090-40022-xx card outputs are fed to the MMP equipped with a BNC output kit for each TOAA card installed. A selection of plug-in level-coordinating attenuators are provided with the BNC output kit. Ideally, the level should be attenuated at the terminating end of the cable.

**8.23** The TOAA 090-40028-10 card outputs are available on the front panel of the card.

**Note:** Do not use a TOAA 090-40028-10 card in a 1:N protection mode.

### D. TOCA Card

**8.24** The TOCA card provides 10 composite clock timing outputs.

**8.25** The card obtains the timing signal from clock card A or B, or clock input A or B bus, according to the priority in Table G. If no input timing signals are present, the TOCA card turns off its ST and INPUT lamps, lights the FAIL lamp, and mutes the outputs.

**8.26** The outputs are fed to the interface panel (if configured with an MMP, the MMP must be equipped with the appropriate output kit, one for each TOCA card installed).

### E. TOGA Card

**8.27** The TOGA card provides ten 2.048 MHz G.703 outputs. A source select circuit obtains the timing signal from clock card A or B, or clock input A or B bus, according to the priority in Table G. If no input timing signals are present, the TOGA card turns off its ST and INPUT lamps, lights the FAIL lamp, and mutes the outputs.

**8.28** A PLL circuit reconstitutes the internal timing signal. The switch-selectable cable compensation settings are transferred to the HS TOGA card during protection switching. The reconstituted timing signal is then applied to each port driver and sent through an impedance-matching transformer.

**8.29** The outputs are fed to the interface panel (if configured with an MMP, the MMP must be equipped with the appropriate output kit, one for each TOGA card installed).

### F. TO-EA5 Card

**8.30** The TO-EA5 card provides ten E1 output signals with framing, or ten 2.048 MHz G.703 output signals. Each output can be set to digital or 2 MHz signals independently. The TO-EA5 card can be used as a stand-alone output card, or can be paired with an adjacent TO-EA5 card to provide redundant (1:1 or 1+1) outputs.

**Note:** Do not use a TO-EA5 card in a 1:N protection mode.

**8.31** The TO-EA5 cards communicate with an MIS<sup>V5</sup> card, which allows configuration of operating parameters and retrieval of status and alarm information for the TO-EA5 cards in a shelf.

### Stand-alone Configuration

**8.32** The card obtains the timing signal from clock card A or clock card B, or clock input A or B bus, according to the priority in Table G. If no input timing signals are present, the TO-EA5 card turns off its ST and INP lamps, lights the FAIL lamp, and squelches the outputs.

**8.33** Framing format (CAS or CCS with or without CRC4) is set by card switches or TL1 commands issued through the MIS<sup>V5</sup> card. Front panel lamps indicate the selected framing format on a per-card basis.

**8.34** Card switches or TL1 commands select the timing signal type (E1 or analog). The E1 or analog timing signal is applied to each port driver and sent through an impedance-matching transformer to the output connector.

**8.35** A switch or TL1 commands can set the port alarm severity to minor or major for the card. Any port alarm generates the alarm selected.

**8.36** The TO-EA5 card can be configured (via switches or TL1 commands) for revertive or nonrevertive switching of the input timing signals. When the card is configured for nonrevertive switching, the four sources on the internal bus are separated into the following groups:

- Clock source group (ST A and ST B)
- Clock input source group (CI A and CI B)

**8.37** In nonrevertive mode, the TO card minimizes input reference switching by not reverting to a previous reference source within the same group. For example, the TO card switches to the ST B reference if ST A fails. The TO card does not revert to ST A when ST A is restored, because the TO card is using a signal in the clock source group. The reference switches to CI A if both ST A and ST B fail. If the TO card is using the CI A reference and one of the sources in the clock group is restored, the TO card reverts to the highest available source (ST A or ST B) in the clock source group.

**8.38** When the TO card is configured for revertive switching, the highest available source is always used (refer to Table G for a prioritized list of the input timing signals). If any source fails, the TO card switches its reference to the source that is next in priority. If any higher priority source is restored, the TO card switches its reference to that source.

### 1:1 Output Protection Configuration

**8.39** The TO-EA5 card 1:1 output protection configuration consists of two TO-EA5 cards installed in adjacent slots, and a double-wide interface module installed on the MMP. Switch settings and TL1 parameters for both cards in the pair must be identical. Both cards in the pair must be using the same input reference from the internal DCD timing bus. Each TO-EA5 card in the 1:1 pair performs all the functions of the TO-EA5 card in a stand-alone configuration, plus communication with the other card in the pair and with the MIS<sup>V5</sup> card. Each pair of TO-EA5 cards provides ten timing outputs.

**8.40** In a 1:1 pair, one card is active and the other card squelches its outputs. If the active card fails, the mate becomes the active card, minimizing disruption to the timing outputs.

**8.41** The card in the odd-numbered slot becomes the active card, and the card in the even-numbered slot becomes the standby card. The active card verifies that the pair have compatible hardware and software revisions, and identical operating parameters, including port output settings.

**8.42** Timing outputs are not available until PLLs on both cards are locked. When the internal TO-EA5 card checks have been completed, a switch setting determines whether timing outputs are immediately enabled, or whether TL1 commands enable the outputs.

**8.43** When a fault is detected, both the active and standby cards determine if the fault is local, or with the other card, or external to the cards. In general, if one of the paired cards is faulty, the fault-free card becomes the active card. For example, if an active card in the odd-numbered slot detects local faults and the standby card is free of faults or contains faults with less severity, the card in the even-numbered slot becomes the active card.

**8.44** The card in the even slot remains the active card until the card faults or all of its ports have failed. If the card in the odd-numbered slot does not

have a major alarm, the card in the odd-numbered slot becomes the master and active card again. If not, or if both cards detect MAJOR alarms, all timing outputs are disabled and the cards are removed from service.

### 1+1 Output Protection Configuration

**8.45** The TO-EA5 card 1+1 output protection configuration consists of two TO-EA5 cards installed in adjacent slots, and a double-wide interface module installed on the MMP. Switch settings and TL1 parameters for both cards in the pair must be identical. Both cards in the pair must be using the same input reference from the internal DCD timing bus. Each TO-EA5 card in the 1+1 pair performs all the functions of the TO-EA5 card in a stand-alone configuration, plus communication with the other card in the pair and with the MIS<sup>V5</sup> card. Each pair of TO-EA5 cards provides ten timing outputs.

**8.46** The timing signals from each card are attenuated so that the final combined output from the interface module is the correct power level.

**8.47** Power-up and fault detection actions are the same as for the 1:1 card pair.

### G. TO-EA Card

**8.48** The TO-EA card may be used in standalone operation, or in redundant-pair (1+1) output protection. The card provides ten outputs, either 2.048 Mb/s E1 outputs with CAS or CCS formats (with or without CRC-4), or ten 2.048 MHz G.703 outputs, or any combination of digital or analog outputs.

**Note:** Do not use a TO-EA card in a 1:N protection mode.

**8.49** The card obtains the timing signal from the DCD internal timing bus (clock card A, clock card B, clock input A or clock input B), according to the priority in Table G. If no input timing signals are present, the TO-EA card turns off its ST and INP lamps, lights the FAIL lamp, and squelches the outputs.

**8.50** The reference input is fed into a PLL circuit, and the reconstituted signal is sent to framing and analog circuit generators; framing format (CAS or CCS with or without CRC4) is set through card switches. Front panel lamps indicate the selected framing format.

**8.51** From the framing and analog circuitry, the signal is sent through a multiplexer where card switches are used to select the timing signal type (E1 or analog).

**8.52** The E1 or 2.048 MHz timing signal is then applied to each port driver and sent through an impedance-matching transformer. Both cards in the pair are power-combined to drive the outputs.

**8.53** The TO-EA card may be switch-selectable for revertive or non-revertive switching of the input signal. For example, if set for revertive switching, and clock card A is supplying timing, if the signal is lost, a switch is made to clock card B. If clock card A comes back, the TO-EA card reverts back to clock card A. If all four signals are bad, the card fails.

**8.54** If set for non-revertive switching, the TO-EA card will not revert backwards through the priority hierarchy (Table G), unless the card currently supplying timing is a clock input card. If the card currently supplying timing is a clock input card, and a clock card becomes active, the TO-EA card will switch to the highest level clock card available. If all four references have been disqualified or failed, the TO-EA card lights the FAIL lamp.

**8.55** The 1+1 output protection mode, when used with the output modules and special cabling, provide smart fault grading, power combination, and redundant output protection. The outputs of the 1+1 card pairs are power combined to drive the outputs simultaneously.

### H. TO-EAN Card

**8.56** The TO-EAN card provides ten E1 output signals with framing, or ten 2.048 MHz G.703 output signals. Consecutive outputs can be set to digital or analog signals. The TO-EAN card can be used as a stand-alone output card or in a 1:N configuration. A TO-EAN card in a managed shelf with 1:N protection requires an MIS<sup>V5</sup> card with version 5.05.01 or later software, and an MCA-5M card.

**Note:** The TO-EAN card cannot be operated in a 1:1 or 1+1 protection configuration.

**8.57** The TO-EAN cards communicate with an MIS<sup>V5</sup> card, which allows configuration of operating parameters and retrieval of status and alarm information for the TO-EAN cards in a shelf.

**8.58** The card obtains the timing signal from clock card A or clock card B, or clock input A or B bus, according to the priority in Table G. If no input timing signals are present, the TO-EAN card turns off its ST and INP lamps, lights the FAIL lamp, and squelches the outputs.

**8.59** Framing format (CAS or CCS with or without CRC4) is set by card switches or TL1 commands issued through the MIS<sup>V5</sup> card. Front panel lamps indicate the selected framing format on a per-card basis.

**8.60** Card switches or TL1 commands select the timing signal type (E1 or analog). The E1 or analog timing signal is applied to each port driver and sent through an impedance-matching transformer.

**8.61** A switch or TL1 commands can set the port alarm severity to minor or major for the card. Any port alarm generates the alarm selected.

**8.62** The TO-EAN card can be configured (via switches or TL1 commands) for revertive or nonrevertive switching of the input timing signals. When the card is configured for nonrevertive switching, the four sources on the internal bus are separated into the following groups:

- Clock source group (ST A and ST B)
- Clock input source group (CI A and CI B)

**8.63** In nonrevertive mode, the TO card minimizes input reference switching by not reverting to a previous reference source within the same group. For example, the TO card switches to the ST B reference if ST A fails. The TO card does not revert to ST A when ST A is restored, because the TO card is using a signal in the clock source group. The reference switches to CI A if both ST A and ST B fail. If the TO card is using the CI A reference and one of the sources in the clock group is restored, the TO card reverts to the highest available source (ST A or ST B) in the clock source group.

**8.64** When the TO card is configured for revertive switching, the highest available source is always used (refer to Table G for a prioritized list of the input timing signals). If any source fails, the TO card switches its reference to the source that is next in priority. If any higher priority source is restored, the TO card switches its reference to that source.

## I. TOEA Card

**8.65** The TOEA card provides 10 E1 outputs with either CAS or CCS formats (with or without CRC-4).

**8.66** The card obtains the timing signal from the DCD internal timing bus (clock card A, clock card B, clock input A or clock input B), according to the priority in Table G. If no input timing signals are present, the TOEA card turns off its ST and INP lamps, lights the FAIL lamp, and squelches the outputs.

**8.67** The outputs are fed to the interface panel (if configured with an MMP, the MMP must be equipped with the appropriate output kit, one for each TOEA card installed).

## J. TOLA Card

**8.68** The TOLA card is available in several models. Each model provides five timing outputs whose frequencies are switch-selectable from one of four groups. Front-panel lamps indicate which group has been selected.

**8.69** The timing outputs for all but the TOLA 090-40023-03 card are RS-422. By connecting between one side of the RS-422 output and signal ground, up to 10 RS-423 outputs are supported. The RS-422 outputs are balanced driver outputs, and the RS-423 outputs are unbalanced driver outputs. The TOLA 090-40023-03 card outputs are RS-232 only and cannot be configured as TTL outputs.

**8.70** A source select circuit obtains the timing signal from either the clock card A or B, or clock input A or B bus according to the priority as shown in Table G. If no input timing signals are present on the buses, the TOLA card turns off both its ST and INPUT lamps, lights the FAIL lamp, and mutes the outputs.

## K. TOTL Card

**8.71** The TOTL card provides 10 framed all-ones T1 timing outputs (1.544 MHz) with line build-out. The TOTL card's output timing signal generator is always enabled.

**8.72** A source select circuit obtains the timing signal from clock card A or clock card B, or clock input A or B bus according to the priority in Table G. If no input timing signals are present on the buses, the TOTL card turns off both its ST and INPUT lamps, lights the FAIL lamp, and mutes the outputs.

**8.73** The framing circuitry allows the user to set the framed all-ones format to D4 or ESF framing. The T1 timing signal is then applied to each port driver and sent through an impedance-matching transformer.

## L. TOTA and TOTA-5 Cards

**8.74** The TOTA and TOTA-5 cards provide 10 T1 (1.544 Mb/s) timing outputs. The TOTA-5 card provides the following features:

- Configuration of port alarm severity, trouble code format, and revertive and nonrevertive switching, using a switch on the card.
- Communication with the MIS<sup>V5</sup> card, which provides configuration of operating parameters and reference control, retrieval of status and alarm information, and the capability to download configuration information to a new MIS<sup>V5</sup> card.

**Note:** A TOTA-M card may be installed in the same shelf as a TOTA-5 card; however, there may be delays in SSM messaging.

**8.75** The card obtains the timing signal from the quad bus according to the priority in Table G. If no input timing signals are present on the buses, the TOTA card turns off both its ST and INPUT lamps, lights the FAIL lamp, and squelches the outputs. The TOTA-5 card turns off both its ST and INP lamps, lights the FAIL lamp, and either squelches the timing outputs or transmits an all-ones signal upon the detection of no input timing signals. The trouble code format on the TOTA-5 card can be configured by using a switch or issuing the appropriate TL1 command via a MIS<sup>V5</sup> card equipped in the shelf.

**8.76** The outputs are fed to the output panel (if configured with an MMP, the MMP must be equipped with the appropriate output kit, one for each card installed).

## TOTA Card Switch

**8.77** SW1 on the TOTA card allows the configuration of TOTA card operating parameters. SW1 can be used to set the framing format to D4 or ESF. SW1 can also be used to enable a TOTA/MCA card combination to register a port alarm if a disabling pin is inserted into one of the disabling jacks on the TOTA card.

## TOTA-5 Card Switch

**Note:** The TOTA-5 card operating parameters that can be configured by SW1 can also be configured by issuing the appropriate TL1 command via the MIS<sup>V5</sup> card (refer to the TL1 User's Guide for information about the MIS<sup>V5</sup> TL1 commands).

**8.78** SW1 on the TOTA-5 card allows the configuration of TOTA-5 card operating parameters. SW1 can be used to set the framing format to D4 or ESF. The switch allows the configuration of the trouble code for a major alarm condition; the user can choose between the transmission of an all-ones signal or the disabling of timing outputs after a major alarm event.

**8.79** Port alarm severity can be set either to minor or major through SW1 on the TOTA-5 card. Any port alarm (up to nine failed ports) will generate the alarm selected. If 10 timing output ports fail, the FAIL lamp lights and a major alarm is declared.

**8.80** SW1 on the TOTA-5 card allows the card to use nonrevertive or revertive switching for the input timing signals. When the card is configured for nonrevertive switching, the four sources on the internal bus are separated into the following individual groups:

- Clock source group (ST A and ST B)
- Clock input source group (CI A and CI B)

**8.81** The sources are nonrevertive within the groups and only revert from the clock input source to the clock source group. For example, the reference switches to ST B if ST A fails. The TO card reference does not revert to ST A when ST A is restored because the TO card is using a signal in the clock source group. The reference switches to CI A if both ST A and ST B fail. If one of the sources in the clock source group is restored, the TO card reverts to the highest available source (ST A or ST B) in the clock source group.

**8.82** When the TO card is configured for revertive switching, the highest available source is always used (refer to Table G for a prioritized list of the input timing signals). If any source fails, the TO card selects the source that is next in priority. If any higher priority source is restored, the TO card selects that source as the reference.

**8.83** SW1 on the TOTA-5 card enables and disables communication between the TOTA-5 and MIS<sup>V5</sup> cards. If the communication is enabled, the user can use TL1 commands to configure operating parameters and retrieve configuration, status, and alarm information from the TOTA-5 card.

## M. TOTA-M Card

**8.84** The TOTA-M card generates SSM messages in addition to performing all of the functions of the TOTA-5 card. The MIS card determines the correct SSM message to send, and commands the TOTA-M card to relay that message. If the MIS card fails or is removed, the TOTA-M card sends a predefined SSM message.

**Note:** Where SSM messages are required, it is recommended that TOTA-M cards replace all other TOTA-series cards in the shelf. The reaction speed of the TOTA-M to deliver the correct message may be affected if a TOTA-M card is installed in the same shelf as a TOTA-5 card.

## 9. MCA-5M CARD AND OUTPUT PROTECTION MATRIX

**9.01** An MCA-5M card provides 1:N output protection in a managed DCD shelf. A managed shelf requires an MIS<sup>V5</sup> card with version 5.05.01 or later software. The MCA-5M card controls the output protection switch matrix, an integral part of the shelf located just above the card slots.

**9.02** The output protection switch matrix contains the HS signal bus, push button switches to select the TO and HS card outputs, and a lamp for each TO and HS slot.

**Caution:** *Some restrictions apply when selecting TO and HS TO cards. If an HS TO card is not compatible with a TO card installed in either a TO or HS slot, incorrect protection switching could occur. Refer to Table E for a list of incompatible HS TO and TO cards.*

**9.03** The TO slots in the shelf contain the cards that normally provide the shelf outputs. The HS slots in the shelf contain one or two hot spare (HS) cards. The MCA-5M card and output protection matrix control whether the card in a TO slot or the card in an HS slot supplies the shelf output signal.

**9.04** Only one of the two HS slots can supply an output signal at a given time. Two HS slots are provided to allow protection for two kinds of TO card, or a deeper level of protection. Activating a protection switch between the TO and HS slots can be either automatic or manual.

**Note:** The MCA-5M card can be in automatic mode or manual mode, as directed by a switch on its circuit board. Automatic mode allows both automatic and manual switching. Manual mode allows only manual switching, and many features of the automatic mode are inactive. It is recommended that the MCA-5M be kept in automatic mode, and this section discusses the automatic mode of the MCA-5M.

**9.05** The MCA-5M card continuously polls the slots in the shelf. If a TO card in 1:N protection reports an alarm, the MCA-5M card activates the relays and lamps in the protection matrix to switch the appropriate HS card to the shelf output path. The AUTO lamp on the MCA-5M card indicates the last switch was automatic.

**9.06** Another TO card of the same type can report a failure while the HS card is active. The MCA-5M card switches the HS card again if the newer failure has a higher priority. The TO card that had been protected is placed back into service.

**Note:** In the event of multiple simultaneous TO card failures, where the failures are in slots with differing priorities, the MCA-5M card may perform multiple HS switches. These switches may cause timing hits at the shelf outputs. Set every TO slot in the shelf to the same priority to avoid this problem.

**9.07** A manual output protection switch is activated when the push button for the TO card and the HS card are pressed simultaneously and held down until both lamps light (about 5 seconds). When the buttons are pressed and held again, the lamps turn off and the TO card delivers the output signal. The MAN lamp on the front panel of the MCA-5M card indicates the previous switch was manual.

**9.08** Whenever manual or automatic protection switching takes place, the TO card automatically transfers option switch settings to the HS card.

**9.09** After a protection switch, individual port alarms on the TO card can be identified by pressing the push button above the switched TO card. The lighted PORT ALM lamps (1 to 10) on the MCA-5M card front panel correspond to the port alarms on the switched TO card.

**9.10** An HS card cannot accidentally be placed in service, and an active TO card cannot accidentally be taken out of service. Activating the HS card requires one of the switch criteria, a TL1 command, or a manual switch.

**9.11** A protection switch remains active until the failed TO card has been replaced and found fault-free by the MIS card and the MCA-5M card. If the protection switch was initiated by TL1 command, the MIS card instructs the MCA-5M card to release the protection switch command.

**9.12** TL1 commands can set the protection priority of any TO card in the shelf. High-priority cards are protected before low-priority cards, including replacing low-priority cards in a protection switch.

**9.13** If protection priority is not used, the MCA-5M card protects cards based on the severity of the fault. The priorities are based on the following failure levels:

- a. Card failure is the highest level. Card failure is defined as circuitry failure, loss of all card outputs, or as a loss of communication between the MCA-5M card and an output card.
- b. Intermediate failure levels are determined by the number of port failures on a card. For example, an output card with four failed ports is judged more severe than an output card with two failed ports.
- c. A card with a single port failure is the lowest failure level.

## 10. MCA-5 CARD AND OUTPUT PROTECTION MATRIX

**10.01** An MCA-5 card provides 1:N output protection in the DCD shelf. An MCA-5 card controls the output protection switch matrix, an integral part of the shelf located just above the card slots.

**10.02** The output protection switch matrix contains the HS signal bus, push button switches to select the TO and HS card outputs, and a lamp for each TO and HS slot.

**Caution:** *Some restrictions apply when selecting TO and HS TO cards. If an HS card is not compatible with a TO card installed in either a TO or HS slot, incorrect protection switching could occur. Refer to Table D for a list of incompatible HS and TO cards.*

**10.03** The TO slots in the shelf contain the cards that normally provide the shelf outputs. The HS slots in the shelf contain one or two hot spare (HS) cards. The MCA-5 card and output protection matrix control whether the card in a TO slot or the card in an HS slot supplies the shelf output signal.

**10.04** Only one of the two HS slots can supply an output signal at a given time. Two HS slots are provided to allow protection for two kinds of TO card, or a deeper level of protection. Activating a protection switch between the TO and HS slots can be either automatic or manual.

**Note:** The MCA-5 card can be in automatic mode or manual mode, as directed by a switch on its circuit board. Automatic mode allows both automatic and manual switching. Manual mode allows only manual switching, and many features of the automatic mode are inactive. It is recommended that the MCA-5 is kept in automatic mode, and this section discusses the automatic mode of the MCA-5.

**10.05** When an active TO card indicates a failure, is removed, or loses communication, the MCA-5 card activates the relays and lamps in the protection matrix and switches the appropriate HS card into the shelf output path. The AUTO lamp on the front panel of the MCA-5 card indicates the previous switch was automatic.

**10.06** A manual output protection switch is activated when the push button for the TO card and the HS card are pressed simultaneously and held down until both lamps light (about 5 seconds). When the buttons are pressed and held again, the lamps turn off and the TO card delivers the output signal. The MAN lamp on the front panel of the MCA-5 card indicates the previous switch was manual.

**10.07** After switching has taken place, individual port alarms can be identified by pressing the push button above the failed card. This action lights the corresponding PORT ALM lamp (1 to 10) on the MCA-5 card front panel.

**10.08** Whenever manual or automatic protection switching takes place, the TO card automatically transfers option switch settings to the HS card.

**10.09** After a protection switch, individual port alarms on the TO card can be identified by pressing the push button above the switched TO card. The lighted PORT ALM lamps (1 to 10) on the MCA-5 card front panel correspond to the port alarms on the switched TO card.

**10.10** The system uses the HS card outputs until the card in the TO slot is manually restored or another TO card reports a higher level failure.

**10.11** An HS card cannot accidentally be placed in service, and an active TO card cannot accidentally be taken out of service. Activating the HS card requires one of the switch criteria or a manual switch.

**10.12** The MCA-5 card keeps track of all TO card failures. During a protection switch, if a port alarm is transferred to the HS card (indicating an external cable problem), the MCA-5 card switches back to the original TO card and locks it out from the protection function until the alarm clears. This lockout is done to prevent the cards from constant protection switching.

**10.13** If the MCA-5 card experiences a communications loss or intermittent communication with all the cards within the shelf, all 10 port alarm lamps will light. At this point, a major alarm is initiated and automatic switching inhibited. Manual switching is activated to allow switching out of cards to isolate the malfunctioning card. This condition remains until the fault is corrected. If the card fails, a major alarm is generated, and the FAIL lamp on the MCA-5 card lights. If this occurs, the card must be replaced.

**10.14** The MCA-5 card provides protection switching for any failed TO card or port. If several failures occur on different TO cards, the MCA-5 card mediates the protection switches on a priority basis. The priorities are based on the following failure levels:

- a. Card failure is the highest level. Card failure is defined as circuitry failure, or as a loss of communication between the MCA-5 card and an output card.
- b. Intermediate failure levels are determined by the number of port failures on a card. For example, an output card with four failed ports is a higher level than an output card with two failed ports.
- c. A card with a single port failure is the lowest failure level.

**10.15** Protection switching is provided for the card with the highest failure level. Examples of failure mediation follow.

- If a single port on a single card fails, a protection switch will be made for the card.
- If multiple cards report failures, protection will be provided for the output card with the highest failure level.
- If protection switching has occurred for one card and another card reports a lower level failure, protection will remain with the card that has the higher failure level.
- If protection switching has occurred for one card and another card reports a higher level failure, protection will be provided for the card with the higher failure level.
- If two cards report the same failure level, protection will be provided for the card that first reported the failure.
- As failures are cleared, protection is provided for the card with the highest current failure level.

## 11. INSERTION CARD DESCRIPTIONS

### A. SCIU Card

**11.01** The SCIU card is an elastic buffer that synchronizes an incoming or outgoing DS1 facility with an external timing source. The SCIU isolates the synchronization of a DS1 circuit while inserting office timing. The SCIU card interfaces a bidirectional DS1 signal and provides retiming in the A direc-



tion while passing the DS1 through in the B direction. The SCIU card is cabled directly into the traffic bearing DS1 bitstream being retimed.

**11.02** A source select circuit in the SCIU card selects the timing reference according to the priorities shown in Table G. With a valid reference, the SYNC lamp lights green. If a reference is not present, the SYNC lamp lights red. The 4 kHz reference is then fed to a PLL circuit with an output frequency of 1.544 Mb/s. This signal is used to clock the elastic buffer output, and the transmit line driver.

**11.03** In the DS1 A direction, the DS1 signal is applied to the line interface and clock recovery circuit. The signal is converted to a unipolar format that passes all coding and logic errors through the SCIU card intact. The input signal is also applied to an off-line framer where framing is monitored. Front panel lamps indicate LOS, OOF, and slips that cause excessive reframe conditions. A set of status leads also provides a framing status output.

**11.04** The output from the clock recovery circuit clocks the signal into the elastic buffer, which is a bank of six 64-bit first in, first out (FIFO) storage devices. The FIFO bank holds two DS1 frames. The DS1 bit stream is clocked into the center of the buffer by the write clock and is clocked by the read clock out of the buffer to the output line driver and line build-out (LBO) circuitry.

**11.05** If the read and write clocks are at the same rate, the data stays at the center of the buffer. However, if the write clock is faster or slower than the stable read clock, the FIFO begins to fill to the left or right. As the FIFO devices fill or empty to 128 bits, a lamp is lit, and the slip warning status lead is activated.

**11.06** When the last FIFO device is full (192 bits or one DS1 frame), a frame slip indication is set and a count started that triggers the excessive slip indication after eight slips. During the count, the frame slip lamp stays lit, but the 64- and 128-bit slip lamps are reset. The slip also activates the SLIP status lamp for 5 seconds.

### Slip Monitoring

**11.07** The SCIU card provides bit slip (preslip) and frame slip indications via front panel lamps and status data to local and remote monitoring systems. DS1 failure (LOS), system reference, and bypass indications are also given.

**11.08** At the frame slip point when the buffer is filled, an uncontrolled slip occurs. However, no zeros are transmitted downstream; thus, only a COFA (change of frame alignment) may be detected by the downstream device if the frame bit moves out from the buffer in the receiving equipment.

**11.09** If the on-line framer detects an LOS or OOF condition in the DS1 input, the SCIU card transmits (if optioned to do so) a framed all-ones signal at the reference rate to allow the downstream device to continue to recover timing. An LOS or OOF condition also resets the slip lamps and counter. The framer may be disabled by an option switch. Disabling the framer allows unframed DS1 signals to be passed by the SCIU card.

**11.10** In the DS1 B direction, the signal enters the SCIU card and is applied to the line interface and clock recovery circuit. The data and recovered clock are then fed directly to the line driver and line build-out. No signal processing occurs other than detecting the LOS conditions, which are indicated with a status point and the bicolored DS1 B lamp. Jitter is attenuated in the B direction.

### DS1 Bypass

**11.11** Both A and B directions have bypass relays in the event of a reference failure, card failure, power loss, or if the SCIU card is removed from the shelf. The SCIU card provides two types of bypass—electronic and relay. If the input reference is lost, an electronic bypass on the SCIU card is activated. A front panel jack is provided to allow manual activation of the electronic bypass. A lit BYPASS lamp indicates the electronic bypass is active.

**11.12** An alarm is set when the electronic bypass is active; this is the same as is set for DS1 A (major, minor, or no alarm). A relay bypass on the SCIU I/O module is activated if the SCIU card fails, if dc power is lost, or if the SCIU card is removed from the shelf.

### Slip Monitor Mode

**11.13** The SCIU card can also be used in a slip monitor-only mode. In the monitor mode, the DS1 A line interface acts as a bridging input. The connection to the DS1 to be monitored must be made through a pair of 432  $\Omega$  bridging resistors or the DSX-1 monitor jack. The DS1 A input is applied to the FIFO, and

slip information is obtained and displayed in reference to the SCIU reference, as above. In the slip monitor mode, DS1 B is disabled.

## B. ESCIU Card

**Note:** The DCD-523 only supports E1 as a balanced input signal at 120  $\Omega$  for the ESCIU card.

**11.14** The ESCIU card is an elastic buffer that synchronizes an incoming or outgoing E1 facility with an external timing source. The ESCIU card isolates the synchronization of an E1 circuit. The ESCIU card interfaces a bidirectional E1 signal and provides retiming in the A direction while passing the E1 through in the B direction. The ESCIU card is cabled directly into the traffic bearing E1 bitstream being retimed.

**11.15** A source select circuit in the ESCIU card selects the timing reference according to the priorities shown in Table G. With a valid reference, the SYNC lamp lights green. If a reference is not present, the SYNC lamp lights red. The 4 kHz reference is then fed to a PLL circuit with an output frequency of 2.048 MHz. This signal is used to clock the elastic buffer output, and the transmit line driver.

**11.16** In the E1 A direction, the E1 signal is applied to the line interface and clock recovery circuit. The signal is converted to a unipolar format that passes all coding and logic errors through the ESCIU card intact. The input signal is also applied to an off-line framer where framing is monitored. Front panel lamps indicate LOS, OOF, and slips that cause excessive reframe conditions. A set of status leads also provides a framing status output.

**11.17** The output from the clock recovery circuit clocks the signal into the elastic buffer, which is a bank of eight 64-bit FIFO storage devices. The FIFO bank holds two E1 frames. The E1 bit stream is clocked into the center of the buffer by the write clock and is clocked by the read clock out of the buffer to the output line driver and line buildout (LBO) circuitry.

**11.18** If the read and write clocks are at the same rate, the data stays at the center of the buffer. However, if the write clock is either faster or slower than the stable read clock, the FIFO begins to fill to the left or right. As the FIFO devices fill or empty to 128 bits, a lamp is lit, and the slip warning status lead is activated.

**11.19** When the last FIFO device is full (256 bits or one E1 frame), a frame slip indication is set and a count started that triggers the excessive slip indication after eight slips. During the count, the frame slip lamp stays lit, but the 128- and 192-bit slip lamps are reset. The slip also activates the SLIP status lamp for 5 seconds.

## Slip Monitoring

**11.20** ESCIU cards provide bit slip (preslip) and frame slip indications via front panel lamps and status data to local and remote monitoring systems. E1 failure (LOS), system reference, and bypass indications are also given.

**11.21** At the frame slip point when the buffer is filled, an uncontrolled slip occurs. However, no zeros are transmitted downstream; thus, only a COFA (change of frame alignment) may be detected by the downstream device if the frame bit moves out from the buffer in the receiving equipment.

**11.22** If the on-line framer detects an LOS or OOF condition in the E1 input, the ESCIU card transmits (if optioned to do so) a framed all-ones signal at the reference rate to allow the downstream device to continue to recover timing. An LOS or OOF condition also resets the slip lamps and counter. The framer may be disabled by an option switch. Disabling the framer allows unframed E1 signals to be passed by the ESCIU.

**11.23** In the E1 B direction, the signal enters the ESCIU card and is applied to the line interface and clock recovery circuit. The data and recovered clock are then fed directly to the line driver. No signal processing occurs other than detecting the LOS conditions, which are indicated with a status point and the bicolored E1 B lamp. Jitter is attenuated in the B direction.

## E1 Bypass

**11.24** Both A and B directions have bypass relays in the event of a reference failure, card failure, power loss, or if the ESCIU card is removed from the shelf.

**11.25** The ESCIU card provides two types of bypass—electronic and relay. If the input reference is lost, an electronic bypass on the ESCIU card is activated. A front panel jack is provided to allow manual activation of the electronic bypass. A lit BYPASS lamp indicates the electronic bypass is active.

**11.26** An alarm is set when the electronic bypass is active; this is the same as is set for E1 A (major, minor, or no alarm).

**Caution:** *A relay bypass on the SCIU interface module is activated if the ESCIU card fails, if dc power is lost, or if the ESCIU card is removed from the shelf.*

### Slip Monitor Mode

**11.27** ESCIU cards can monitor slips without synchronizing the signal. In the slip monitor mode, the E1 A line interface acts as a bridging input. The connection to the E1 to be monitored must be made using a bridging unit available from Symmetricom. The E1 A input is applied to the FIFO, where slip information is obtained and displayed as above. In the slip monitor mode, E1 B is disabled.

## 12. PSM CARD DESCRIPTION

**12.01** The PSM card monitors up to four external inputs. The PSM-E and PSM-E<sup>V5</sup> cards monitor 2.048 Mb/s signals, the PSM-T and PSM-T<sup>V5</sup> cards monitor 1.544 Mb/s signals, and the PSM-EA card monitors 2.048 Mb/s and 2.048 MHz signals. The number of inputs scanned and the framing type can be changed by TL1 commands from a remote PC or by switch settings on the card (refer to the TL1 User's Guide for information on commands). An MIS card must be installed in the system for communications with an external computer.

**12.02** PSM<sup>V5</sup> cards provide additional features when used with an MIS<sup>V5</sup> card. The PSM card communicates with the MIS card, which allows the user to control the card, and retrieve status and alarm information. To maintain MIS-to-PSM card communications, an MIS<sup>V5</sup> card must be installed when a PSM<sup>V5</sup> card is installed in the shelf.

**12.03** The PSM<sup>V5</sup> card works with the MIS<sup>V5</sup> card to provide the user with status and alarm information and allow the user to control the card. Refer to the TL1 User's Guide (provided with each MIS card) for information on the TL1 commands associated with the PSM cards.

**12.04** PSM cards can be installed in any two adjacent TO slots in the master shelf except the TO3/TO4 position. (This exception is due to the shelf

stiffener in the middle of those slot pairs, which precludes a double-wide card.) The maximum number of PSM cards is two in the master shelf and five in each expansion shelf, with a limit of seven PSM cards in any single system. The maximum number of Version 5 PSM cards allowed in a single system is limited only to the number of available TO slots in the shelf.

**12.05** The signals to be monitored are connected to the same output panel used by the TO cards. The cables are connected to wire-wrap modules or 10-port BNC interface modules mounted on the MMP, or the wire-wrap panel.

**12.06** The PSM card scans each enabled input plus the two internal references to monitor transmission and performance parameters. Each input is sampled for 120 ms for a total elapsed sample time of approximately 1 second. The first 240 ms is ignored to ensure measurement stabilization. The sample rate for all input signals is 1 Hz. Spans that are not enabled are not checked. Scanning continues to cycle through the active inputs while the card is powered.

**12.07** The PSM card reports an event when the transmission event count exceeds the assigned threshold. The factory-set thresholds are as follows:

- Out of frame (OOF): 4
- Alarm indication signal (AIS): 4
- Bipolar violations (BPV): 16
- Cyclic Redundancy Check (CRC): 16
- Loss of signal (LOS): 1

**12.08** The OOF and AIS counts represent the number of errored seconds for each event during the time the PSM scans the input. The BPV and CRC counts represent the actual number of errors counted while the input is being scanned. All thresholds except LOS are user-configurable, and the report given when a threshold is exceeded can be changed from a condition to an alarm.

**12.09** Both the phase and frequency of the input signals are monitored in comparison to the active clock card or clock input signal in the shelf. Calculations are then made for MTIE and TDEV over various time periods. The time periods and the factory-set thresholds are listed in Table L.

**12.10** The monitored parameters and calculated values are stored in ninety-six 15 minute bins. The bins are first-in, first-out (FIFO) so that when the 97th interval is completed, the oldest stored 15 minute data is overwritten. The data in these bins is the 1 minute averaged raw phase values, not the 1 second data points. Therefore, a 15 minute bin will contain 15 data points.

**Table L. PSM Card Factory Threshold Settings for MTIE and TDEV**

TIME (s)	MTIE THRESHOLD (ns)	TDEV THRESHOLD (ns)
1	300	100
4	300	100
16	350	125
64	450	255
128	650	360
512	1,000	—
900	1,000	—
Note: The thresholds shown can be changed by TL1 command.		

**12.11** Remote control via the MIS card may be performed. For detailed information on available parameters that can be remotely accessed, refer to the TL1 User’s Guide (provided with each MIS card).

**12.12** If an input has been disabled by switches on the PSM card or by TL1 command, performance data will not be collected on that input until that input is enabled.

**12.13** If the PSM card is removed from the shelf, all error counts and stability measurement data registers are set to zero. Also, all options set by command will revert to the values set by switches on the PSM card. A FAIL lamp on the front panel of the card lights red if the self-diagnostic tests fail.

**12.14** There is a separate front-panel REF lamp for each reference source, and each lamp indicates the status of the corresponding reference input. These lamps light green when an input is enabled and has passed error check. They light red when an input is enabled and fails the error check (high CRC, OOF, BPV, AIS, or LOS). The REF lamps do not light if the associated input is not enabled.

**12.15** There is a separate front-panel TOL lamp for each reference source, and each lamp indicates the stability of the corresponding reference input. These lamps are off if the input is not enabled, and off if the input is enabled and within stability tolerance. The TOL lamps light yellow if the input is enabled and out of stability tolerance as measured by MTIE and TDEV.

**12.16** The ST lamp on the front panel is off if no clock cards are active. This lamp lights green if at least one clock card is active.

**12.17** The INP lamp is off if no clock cards or clock input cards are active, but lights green if at least one clock card or clock input card is active.

**13. SPECIFICATIONS**

**13.01** The DCD-523 System specifications are listed in Table M. Table lists the bridging isolator specifications. Table O lists the individual card specifications. The specification terms are explained in Table P.

Table M. System Specifications

ITEM	SPECIFICATION		
<b>CLOCK SUMMARY</b>			
Source Holdover (0 h to 24 h @ 25 °C): Holdover (0 h to 24 h @ 0 °C to 45 °C): Pull-in Range	<u>ST2E Clock</u> Rb Vapor Cell	<u>ST2</u> Rb Vapor Cell	<u>ST3E (Note)</u> TCXO
	$\pm 2.0 \times 10^{-11}$	$\pm 4.0 \times 10^{-11}$	$\pm 3.0 \times 10^{-10}$
	$\pm 5.0 \times 10^{-11}$ $\pm 1.6 \times 10^{-8}$	$\pm 1.0 \times 10^{-10}$ $\pm 1.6 \times 10^{-8}$	$\pm 1.0 \times 10^{-8}$ $\pm 5.6 \times 10^{-6}$ or $\pm 2.0 \times 10^{-6}$
Source Holdover (0 h to 24 h, 25 °C): Holdover (0 h to 24 h, 0 °C to 45 °C): Pull-in Range	<u>TNC-E Clock</u> Rb Vapor Cell	<u>TNC</u> TCXO	<u>LNC (Note)</u> TCXO
	$\pm 2.0 \times 10^{-11}$	$\pm 3.0 \times 10^{-10}$	$\pm 3.0 \times 10^{-10}$
	$\pm 5.0 \times 10^{-11}$ $\pm 1.6 \times 10^{-8}$	$\pm 1.0 \times 10^{-9}$ $\pm 0.75 \times 10^{-6}$	$\pm 1.0 \times 10^{-8}$ $\pm 5.6 \times 10^{-6}$ or $\pm 2.0 \times 10^{-6}$
Note: Switch-selectable pull-in ranges			
<b>COMMUNICATIONS</b>			
See the MIS card section in Table O.			
<b>ALARM AND STATUS OUTPUTS</b>			
See the MIS or SAI card section in Table O.			
<b>SSM</b>			
E1 Quality Levels Supported	QL-DNU	QL-NONE	QL-NORM
	QL-PRC	QL-RES	QL-SEC
	QL-SSUL	QL-SSUT	QL-UNK
T1 Quality Levels Supported	QL-DUS	QL-NONE	QL-NORM
	QL-PRS	QL-RES	QL-SMC
	QL-ST2	QL-ST3	QL-ST3E
	QL-ST4	QL-STU	QL-TNC
<b>DELAYS</b>			
Persistence Delay	0 ms to 2000 ms, in 100 ms steps		
Nonswitching Message Delay	0 ms to 2000 ms, in 100 ms steps		
Switching Message Delay	0 ms to 2000 ms, in 100 ms steps		
Holdover Message Delay	0 ms to 3600 s, in 1 s steps		
Holdoff Delay	0 ms to 2000 ms, in 100 ms steps		
Wait-to-Restore Delay	0 min to 15 min, in 1 min steps		
Note: These delays can be set by TL1 command.			

Table M. System Specifications

ITEM	SPECIFICATION
<b>POWER</b>	
Voltage	-42 V dc to -56 V dc
Shelf Current (Note)	1.5 A (For the first 30 min, the TNC-E and ST2E needs 4 A)
Shelf Fusing	5 A
Recommended Shelf Source Fusing	7.5 A to 10 A
Note: Current specifications for fully loaded shelves.	
<b>PHYSICAL</b>	
Shelf Assembly (HxWxD)	262.9 mm x 584.2 mm x 279.4 mm (10.35 inches x 23.0 inches x 11.0 inches) (6 RU)
Interface Panel (HxWxD): Wire-wrap Panel Modular Mounting Panel	88.9 mm x 584.2 mm x 279.4 mm (3.5 inches x 23.0 inches x 11.0 inches) (2 RU) 133 mm x 584.2 mm x 279.4 mm (5.25 inches x 23.0 inches x 11.0 inches) (3 RU)
1-slot card (HxWxD)	152.4 mm x 19.1 mm x 244.34 mm + 6.35 mm (for latch) (6.0 inches x 0.75 inches x 9.625 inches + 0.25 inch [for latch])
2-slot card (HxWxD)	152.4 mm x 41.3 mm x 244.34 mm + 6.35 mm (for latch) (6.0 inches x 1.625 inches x 9.625 inches + 0.25 inch [for latch])
5-slot card (HxWxD)	152.4 mm x 95.5 mm x 244.34 mm + 6.35 mm (for latch) (6.0 inches x 4.0 inches x 9.625 inches + 0.25 inch [for latch])
Environmental Operating Temperature Operating Humidity	0 °C to 45 °C 0% to 95%, noncondensing

Table N. Bridging Isolator Specifications

ITEM	SPECIFICATION
Impedance (Input and Output)	75 $\Omega$ (wire-wrap: 120 $\Omega$ )
Insertion Loss (Input to Output)	<0.01 dB @ 8 kHz
Bridging Insertion Loss	20.8 dB (wire-wrap: 20 dB)
Connector Type (Note)	BNC (p/n 093-45030-01, 093-45030-31) SMB (p/n 093-45030-02, 093-45030-32) Siemens 1.6/5.6 (p/n 093-45030-03, 093-45030-33) Siemens 1.0/2.3 (p/n 093-45030-35) Wire-wrap (p/n 093-45030-04)
Dimensions (cm)	10.2 cm (4 in) x 4.4 cm (1.7 in) x 2.8 cm (1.1 in) (wire-wrap: 3.6 cm [1.4 in] x 7.2 cm [2.8 in] x 84 cm [33 in])
Weight	60 g (2.1 oz) (wire-wrap: 25 g [0.88 oz])
Operating Temperature	-40 °C to +65 °C
Humidity	95% noncondensing
Note: Bridging isolators with a suffix -0x on the part number supply one bridged signal; bridging isolators with a suffix -3x on the part number supply three bridged signals.	

Table O. Card Specifications

ITEM	SPECIFICATION
<b>ACI CARD</b>	
Number of Inputs	1
Input Signal Type	2.048 MHz (ITU G.703, Table 10) Analog 1.0 MHz, 5.0 MHz, and 10.0 MHz (tolerance $\pm 50$ ppm)
Input Signal Level	0.3 V to 1.5 V rms
Input Impedance	75 $\Omega$ unbalanced
Input Frequency (sine wave)	Switch-selectable: 10 MHz, 5 MHz, 2.048 MHz, 1 MHz
Clock Holdover	2 s with 0 phase shift
Transfer Time	2 s
SSM Processing	No (SSM quality level can be assigned via version 5.04 or higher MIS <sup>V5</sup> card)
<b>CI -EA CARD</b>	
Number of Inputs	1
Input Signal Type	Switch-selectable: Digital (ITU G.703, Table 6), or Analog (ITU G.703, Table 10)
Input Signal Parameters Monitored	Loss of sync or AIS, OOF, COFA, and LOS
Input Error Threshold	One or more OOFs in 10 s; error rate $10^{-6}$ (based on code violations)
Framing Protocols	Switch-selectable: CAS or CCS framing with/without CRC-4 per ITU G.704
Line Coding	AMI or HDB3
Input Level, Terminated	1.0 V to 3.5 V base-to-peak (specific terminations are supported by separate input modules)
Input Impedance	120 $\Omega$ balanced or 75 $\Omega$ unbalanced
Jitter Tolerance	Per ITU G.823 (Table 2)
SSM Processing	No (SSM quality level can be assigned via version 5.04 or higher MIS <sup>V5</sup> card)



Table O. Card Specifications (Contd)

ITEM	SPECIFICATION
<b>CI CARD</b>	
Number of Inputs	1
DS1 Input Signal Monitor	Loss of signal (LOS) or AIS, OOF, and COFA
Input Error Threshold	Error rate of $10^{-6}$ (based on BPV)
Framing Protocols	D4 /ESF
Input Signal Level, Terminated	1.0 V to 3.5 V base-to-peak, -10 dB up to 199 m (655 ft) from DSX
Input Signal Level, Bridged	0.1 V to 0.35 V base-to-peak, up to 199 m (655 ft) from DSX
Input Signal Impedance	100 $\Omega$ (T1) or 133 $\Omega$ (CC)
Input Signal Jitter Tolerance	10-unit intervals, peak-to-peak, 0 Hz to 310 Hz; 0.3-unit intervals, 10 kHz to 50 kHz
Input Format	64 kb/s all-ones, RTZ, 62.5% duty cycle, up to 455 m (1500 ft) from source
Input Level	1.5 V to 4.0 V base-to-peak
Input Impedance	100 $\Omega$ or 133 $\Omega$ balanced, 50 $\Omega$ unbalanced
SSM Processing	No (SSM quality level can be assigned via version 5.04 or higher MIS <sup>V5</sup> card)
<b>DCIM-EA CARD</b>	
Number of Inputs	2
Input Signal Type	Digital: E1 (ITU G.703, Table 6) 2.048 MHz (ITU G.703, Table 10)
Input Parameters Monitored	CRC, OOF, BPV, AIS, and LOS (CRC and BPV monitored full-time in 15 min bins)
Factory-set Thresholds (all except LOS may be changed by TL1 commands)	AIS: 1 BPV: 16 CRC: 16 LOS:1 OOF: 1
Framing Protocols	CAS or CCS framing with/without CRC-4 per ITU G.704 is selectable via TL1 command only
Line Coding	HDB3
Input Level, Terminated	1.0 V to 3.5 V base-to-peak
Input Level, Bridging	0.1 V to 0.35 V base-to-peak
Input Impedance	120 $\Omega$ balanced or 75 $\Omega$ unbalanced
Jitter Tolerance	Per ITU G.823 (Table 2)
SSM Processing	Yes

Table O. Card Specifications (Contd)

ITEM	SPECIFICATION
<b>DCIM-T CARD</b>	
Number of Inputs	2
Input Signal Type	DS1
Input Signal Parameters Monitored	CRC, OOF, BPV, AIS, and LOS (CRC and BPV monitored full-time in 15 min bins)
Factory-set Thresholds (all except LOS may be changed by TL1 commands)	AIS: 1 BPV: 16 CRC: 16 LOS:1 OOF: 1
Framing Protocols	D4 /ESF or autoframer, set by TL1 command
Line Coding	AMI or B8ZS
Input Signal Level, Terminated	1.0 V to 3.5 V base-to-peak
Input Signal Level, Bridged	0.1 V to 0.35 V base-to-peak
Input Signal Jitter Tolerance	10-unit intervals, peak-to-peak, 0-310 Hz; 0.3-unit intervals, 10 kHz to 50 kHz (per Pub TA-TSY-000378)
Input Signal Impedance	100 $\Omega$ balanced or 50 $\Omega$ unbalanced
Input Frequency	1.544 Mb/s
SSM Processing	Yes

Table O. Card Specifications (Contd)

ITEM	SPECIFICATION
<b>MRC-EA CARD AND MRC-EA<sup>V5</sup> CARD</b>	
Number of Inputs	4
Input Signal Type	Digital: E1 (ITU G.703, Table 6) 2.048 MHz (ITU G.703, Table 10)
Input Signal Priority	GPS (priority level 1), LORAN (priority level 2), Cesium (priority level 3), Network (priority level 4)
Input Parameters Monitored	CRC, OOF, BPV, AIS, and LOS
Factory-set Thresholds (all except LOS may be changed by TL1 commands)	AIS: 1 BPV: 16 CRC: 16 LOS:1 OOF: 1
Framing Protocols	CAS or CCS framing with/without CRC-4 per ITU G.704 is selectable via TL1 command only
Line Coding	HDB3
Input Level, Terminated	1.0 V to 3.5 V base-to-peak
Input Level, Bridging	0.1 V to 0.35 V base-to-peak
Input Impedance	120 $\Omega$ balanced or 75 $\Omega$ unbalanced
Jitter Tolerance	Per ITU G.823 (Table 2)
SSM Processing	MRC-EA: No MRC-EA <sup>V5</sup> :No (SSM quality level can be assigned via version 5.04 or higher MIS <sup>V5</sup> card)

Table O. Card Specifications (Contd)

ITEM	SPECIFICATION
<b>MRC-T CARD AND MRC-T<sup>V5</sup> CARD</b>	
Number of Inputs	4
Input Signal Type	DS1
Input Signal Type and Priority	GPS (priority level 1), LORAN (priority level 2), Cesium (priority level 3), Network (priority level 4)
Input Signal Parameters Monitored	CRC, OOF, BPV, AIS, and LOS
Factory-set Thresholds (all except LOS may be changed by TL1 commands)	CRC:16 OOF: 4 BPV: 16 AIS: 4 LOS:1
Framing Protocols	D4 /ESF or autoframer, set by TL1 command
Line Coding	AMI or B8ZS
Input Signal Level, Terminated	1.0 V to 3.5 V base-to-peak
Input Signal Level, Bridged	0.1 V to 0.35 V base-to-peak
Input Signal Jitter Tolerance	10-unit intervals, peak-to-peak, 0 Hz to 310 Hz; 0.3-unit intervals, 10 kHz to 50 kHz (per Pub TA-TSY-000378)
Input Signal Impedance	100 $\Omega$ balanced or 50 $\Omega$ unbalanced
Input Frequency	1.544 Mb/s
SSM Processing	MRC-T: No MRC-T <sup>V5</sup> : No (SSM quality level can be assigned via version 5.04 or higher MIS <sup>V5</sup> card)

Table O. Card Specifications (Contd)

ITEM	SPECIFICATION
<b>TNC-E AND ST2E CARDS (Refer to Table P for definitions of specification terms) (See Note)</b>	
Source	Rubidium atomic oscillator
<u>Clock Holdover Stability:</u> 0 h to 24 h, 25 °C 0 h to 24 h, 0 °C to 45 °C 30 days	$\pm 2 \times 10^{-11}$ $\pm 5 \times 10^{-11}$ $\pm 1 \times 10^{-10}$
Accuracy (20 years)	$1.0 \times 10^{-9}$
Input Tolerance	$\pm 1.6 \times 10^{-8}$
Pull-in Range	$\pm 1.6 \times 10^{-8}$
Lock Range	$\pm 1 \times 10^{-9}$
Allowable Reference Drift (within 5 min)	$\pm 1 \times 10^{-9}$
Convergence Time	$\leq 1$ h
Warm-up Time	$\leq 30$ min
Operating Temperature	0 °C to 45 °C
Industry Specifications	ITU G.812 transit node clock specifications for slave clocks
SSM Processing	No (SSM quality level can be assigned via version 5.04 or higher MIS <sup>V5</sup> card)
Note: When an ST2E Issue A or B card is in a shelf, use only an LPR for an input reference source. When an ST2E Issue D (or later) card in a shelf, use either an LPR or network feed for an input reference source.	

Table O. Card Specifications (Contd)

ITEM	SPECIFICATION
<b>TNC CARD</b>	
Source	Oven-controlled crystal oscillator
<u>Clock Holdover Stability:</u> 0 h to 24 h, 25 °C 0 h to 24 h, 0 °C to 45 °C 30 days	$\pm 3.0 \times 10^{-10}$ $\pm 1.0 \times 10^{-9}$ $\pm 1.0 \times 10^{-8}$
Accuracy (20 years)	$1.0 \times 10^{-6}$
Input Tolerance	$\pm 0.75 \times 10^{-6}$
Pull-in Range	$\pm 0.75 \times 10^{-6}$
Lock Range	$\pm 1.0 \times 10^{-7}$
Convergence Time	$\leq 1$ h
Warm-up Time	30 min
Operating Temperature	0 °C to 45 °C
Industry Specifications	ITU G.812 transit node clock specifications for slave clocks and ETSI 3017
SSM Processing	No (SSM quality level can be assigned via version 5.04 or higher MIS <sup>V5</sup> card)
<b>LNC CARD</b>	
Source	Oven-controlled crystal oscillator
<u>Clock Holdover Stability:</u> 0 h to 24 h, 25 °C 0 h to 24 h, 0 °C to 45 °C 30 days	$\pm 3.0 \times 10^{-10}$ $\pm 1.0 \times 10^{-8}$ $\pm 1.0 \times 10^{-8}$
Accuracy (20 years)	$1.0 \times 10^{-6}$
Input Tolerance	$\pm 5.6 \times 10^{-6}$ or $\pm 2.0 \times 10^{-6}$ (switch selectable)
Pull-in Range	$\pm 5.6 \times 10^{-6}$ or $\pm 2.0 \times 10^{-6}$ (switch selectable)
Lock Range	$\pm 1.0 \times 10^{-7}$
Convergence Time	$\leq 1$ h
Warm-up Time	$\leq 30$ min
Operating Temperature	0 °C to 45 °C
SSM Processing	No (SSM quality level can be assigned via version 5.04 or higher MIS <sup>V5</sup> card)

Table O. Card Specifications (Contd)

ITEM	SPECIFICATION
<b>ST3E CARD</b>	
Source	Oven-controlled crystal oscillator
<u>Clock Holdover Stability:</u> 0 h to 24 h, 25 °C 0 h to 24 h, 0 °C to 45 °C 30 days	$\pm 3.0 \times 10^{-10}$ $\pm 1.0 \times 10^{-8}$ $\pm 1.0 \times 10^{-8}$
Accuracy (20 years)	$1.0 \times 10^{-6}$
Input Tolerance	$\pm 5.6 \times 10^{-6}$ or $\pm 2.0 \times 10^{-6}$ (switch selectable)
Pull-in Range	$\pm 5.6 \times 10^{-6}$ or $\pm 2.0 \times 10^{-6}$ (switch selectable)
Lock Range	$\pm 1.0 \times 10^{-7}$
Convergence Time	$\leq 1$ h
Warm-up Time	30 min
Operating Temperature	0 °C to 45 °C
SSM Processing	No (SSM quality level can be assigned via version 5.04 or higher MIS <sup>V5</sup> card)
<b>EA10 CARD</b>	
Number of Outputs	10
Output Type (switch-selectable on a per port basis)	Digital E1 2.048 Mb/s (ITU G.703, Table 6) (any individual port) or 2.048 MHz (ITU G.703, Table 10) (any individual port)
Waveform	Digital E1: 2.37 V $\pm 10\%$ (75 $\Omega$ ); 3.0 V $\pm 10\%$ (120 $\Omega$ ); Bipolar return to zero (RTZ) per ITU G.703 Table 6 or 2.048 MHz: 75 $\Omega$ : 1.5 V peak maximum, 0.75 V peak minimum, 120 $\Omega$ : 1.9 V peak maximum, 1.0 V peak minimum per ITU G.703, Table 10
Wave Shape	Digital E1: Rectangular, pulse width 244 ns $\pm 25$ ns, pulse interval 488 ns per ITU G.703 (Figure 15) or Analog: Square wave per ITU G.703, Figure 21
Impedance	120 $\Omega$ balanced or 75 $\Omega$ unbalanced
Framing	CCS or CAS, with or without CRC-4
Protection	1:1, 1+1 (must use double-wide output module), or stand-alone
SSM Processing	No

Table O. Card Specifications (Contd)

ITEM	SPECIFICATION
<b>EA10M CARD</b>	
Number of Outputs	10
Output Type (switch-selectable on a per port basis)	Digital E1 2.048 Mb/s (ITU G.703, Table 6) (any individual port) or 2.048 MHz (ITU G.703, Table 10) (any individual port)
Waveform	Digital E1: 2.37 V $\pm$ 10% (75 $\Omega$ ); 3.0 V $\pm$ 10% (120 $\Omega$ ); Bipolar return to zero (RTZ) per ITU G.703 Table 6 or 2.048 MHz: 75 $\Omega$ : 1.5 V peak maximum, 0.75 V peak minimum, 120 $\Omega$ : 1.9 V peak maximum, 1.0 V peak minimum per ITU G.703, Table 10
Wave Shape	Digital E1: Rectangular, pulse width 244 ns $\pm$ 25 ns, pulse interval 488 ns per ITU G.703 (Figure 15) or 2.048 MHz: Square wave per ITU G.703, Figure 21
Impedance	120 $\Omega$ balanced or 75 $\Omega$ unbalanced
Framing	CCS or CAS, with or without CRC-4
Protection	1:1, 1+1 (must use double-wide output module), or stand-alone
SSM Processing	Yes
<b>TOGA CARD</b>	
Number of Outputs	10
Output Type	2.048 MHz (ITU G.703, Table 10)
Waveform	75 $\Omega$ : 1.5 V peak maximum, 0.75 V peak minimum, 120 $\Omega$ : 1.9 V peak maximum, 1.0 V peak minimum per ITU G.703, Table 10
Wave Shape	Square wave per ITU G.703, Figure 21
Impedance	75 $\Omega$ unbalanced or 120 $\Omega$ balanced
Output Frequency	2.048 MHz
Protection	1+1 (must use double-wide output module), stand-alone, or 1:N
SSM Processing	No



Table O. Card Specifications (Contd)

ITEM	SPECIFICATION
<b>TOEA CARD</b>	
Number of Outputs	10
Output Type	Digital E1 2.048 Mb/s $\pm$ 50 ppm
Waveform	2.37 V $\pm$ 10% (75 $\Omega$ ); 3.0 V $\pm$ 10% (120 $\Omega$ ); Bipolar return to zero (RTZ)
Wave Shape	Rectangular, pulse width 244 ns $\pm$ 25 ns, pulse interval 488 ns per ITU G.703 (Figure 15)
Impedance	120 $\Omega$ balanced or 75 $\Omega$ unbalanced
Drive Capability	0 ft to 655 ft (0 m to 200 m) of twisted-pair, 0.643 mm (22 AWG) cable
Framing	CCS or CAS, with or without CRC-4
Protection	Stand-alone or 1:N
SSM Processing	No
<b>TO-EA CARD, TO-EAN CARD, AND TO-EA5 CARD</b>	
Number of Outputs	10
Output Type (switch-selectable on a per port basis)	Digital E1 2.048 Mb/s (ITU G.703, Table 6) (any individual port) or 2.048 MHz (ITU G.703, Table 10) (any individual port)
Waveform	Digital E1: 2.37 V $\pm$ 10% (75 $\Omega$ ); 3.0 V $\pm$ 10% (120 $\Omega$ ); Bipolar return to zero (RTZ) per ITU G.703 Table 6 or 2.048 MHz: 75 $\Omega$ : 1.5 V peak maximum, 0.75 V peak minimum, 120 $\Omega$ : 1.9 V peak maximum, 1.0 V peak minimum per ITU G.703, Table 10
Wave Shape	Digital E1: Rectangular, pulse width 244 ns $\pm$ 25 ns, pulse interval 488 ns per ITU G.703 (Figure 15) or 2.048 MHz: Square wave per ITU G.703, Figure 21
Impedance	120 $\Omega$ balanced or 75 $\Omega$ unbalanced
Framing	CCS or CAS, with or without CRC-4
Protection	TO-EA5: Stand-alone or 1:1, 1+1 (must use double-wide output module) TO-EA: Stand-alone or 1+1 (must use double-wide output module) TO-EAN: Stand-alone or 1:N
SSM Processing	No

Table O. Card Specifications (Contd)

ITEM	SPECIFICATION
<b>TOAA CARD (090-40022-01, -02, -03, -05, -15, and 090-40028-10)</b>	
Number of Outputs	2
Output Type	Analog
Waveform	090-40022-01, -02, -03, -05, and 090-40028-10: 1 V rms 090-40022-15: 2 V rms
Wave Shape	Sine wave
Impedance	75 $\Omega$ unbalanced (50 $\Omega$ unbalanced for 090-40022-02)
Output Frequency	Switch-selectable 090-40022-01, -02: 2.048 MHz, 1.0 MHz, 512 kHz, or 64 kHz 090-40022-03: 2.048 MHz, 1.0 MHz, 512 kHz, or 8 kHz 090-40022-05, -15: 5 MHz 090-40028-10: 1 MHz, 5 MHz, or 10 MHz
Level Attenuators	090-40022-xx: 0 dB, 3 dB, 3.5 dB, 30 dB, 60 dB (none for 090-40028-10)
Protection	090-40022-xx: Stand-alone or 1:N 090-40028-10: Stand-alone
SSM Processing	No
<b>TOCA CARD</b>	
Number of Outputs	10
Output Type	Composite clock (digital 64/8 kb/s)
Waveform	2.7 V to 3.5 V peak, 3 V nominal; bipolar RTZ; all-ones with BPV every eighth pulse
Wave Shape	Rectangular, rise time <500 ns, pulse width 9.8 $\mu$ s $\pm$ 5%, pulse interval 15.6 $\mu$ s $\pm$ 5%
Impedance	133 $\Omega$ balanced
Duty Cycle	62.5%
Output Drive Capability	0 m to 910 m (0 ft to 3000 ft) of twisted-pair, 25.3 mils, 0.643 mm (22 AWG) cable in the following lengths: 0 m to 455 m (0 ft to 1500 ft), 456 m to 606 m (1501 ft to 2000 ft), 607 m to 758 m (2001 ft to 2500 ft), and 759 m to 910 m (2501 ft to 3000 ft)
Switching	Provides hitless switching when used with 090-45230-03 Shelf
Protection	Stand-alone or 1:N
SSM Processing	No

Table O. Card Specifications (Contd)

ITEM	SPECIFICATION
<b>TOTA CARD AND TOTA-5 CARD</b>	
Number of Outputs	10
Output Type	DS1
Waveform	2.4 V to 3.6 V peak, 3.5 V nominal; bipolar return to zero; all-ones; ESF or D4 format
Wave Shape	Rectangular, rise time <150 ns, pulse width 350 ns $\pm$ 50 ns, pulse interval 648 ns $\pm$ 0.005%
Impedance	100 $\Omega$ balanced
Overshoot	To +20% and –45% of peak-to-base amplitude
Duty Cycle	50% nominal
Output Drive Capability	0 m to 199 m (0 ft to 655 ft) of twisted-pair, 25.3 mils, 0.643 mm (22 AWG) ABAM cable
Switching	Provides hitless switching when used with 090-45230-03 Shelf (TOTA-5 card)
Protection	Stand-alone or 1:N
SSM Processing	No
<b>TOTA-M CARD</b>	
Number of Outputs	10
Output Type	DS1
Waveform	2.4 V to 3.6 V peak, 3.5 V nominal; bipolar return to zero; all-ones; ESF or D4 format
Wave Shape	Rectangular, rise time <150 ns, pulse width 350 ns $\pm$ 50 ns, pulse interval 648 ns $\pm$ 0.005%
Impedance	100 $\Omega$ balanced
Overshoot	To +20% and –45% of peak-to-base amplitude
Duty Cycle	50% nominal
Output Drive Capability	0 m to 199 m (0 ft to 655 ft) of twisted-pair, 25.3 mils, 0.643 mm (22 AWG) ABAM cable
Protection	Stand-alone or 1:N
SSM Processing	Yes

Table O. Card Specifications (Contd)

ITEM	SPECIFICATION					
<b>TOLA 090-40023-01 CARD</b>						
Number of Outputs	5 RS-422 or 10 RS-423 (TTL)					
Output Type	RS-422 or RS-423 (TTL)					
Wave Amplitude	2 V to 6 V pp for RS-422 (balanced) into 100 $\Omega$ >3 V for RS-423 (unbalanced) into 450 $\Omega$					
Wave Shape	Square wave					
Impedance	100 $\Omega$ resistive, balanced; 450 $\Omega$ resistive, unbalanced					
Data Rates (four frequency groups)—From wire-wrap panel	<u>Group</u>	<u>Out 1</u>	<u>Out 2</u>	<u>Out 3</u>	<u>Out 4</u>	<u>Out 5</u>
	0	4 kb/s	8 kb/s	64 kb/s	1.544 Mb/s	1.544 Mb/s
	1	256 kb/s	512 kb/s	2.048 Mb/s	1.544 Mb/s	1.544 Mb/s
	2	384 kb/s	768 kb/s	1.536 Mb/s	1.544 Mb/s	1.544 Mb/s
	3	1.544 Mb/s	1.544 Mb/s	1.544 Mb/s	1.544 Mb/s	1.544 Mb/s
Data Rates (four frequency groups)—From DB9 connector	<u>Group</u>	<u>Out 1</u>	<u>Out 2</u>	<u>Out 3</u>	<u>Out 4</u>	<u>Out 5</u>
	0	1.544 Mb/s	1.544 Mb/s	64 kb/s	8 kb/s	4 kb/s
	1	1.544 Mb/s	1.544 Mb/s	2.048 Mb/s	512 kb/s	256 kb/s
	2	1.544 Mb/s	1.544 Mb/s	1.536 Mb/s	768 kb/s	384 kb/s
	3	1.544 Mb/s	1.544 Mb/s	1.544 Mb/s	1.544 Mb/s	1.544 Mb/s
Cable Lengths (maximum in meters and feet; RS-422) 20.1 mils, 0.511 mm (24 AWG) Twisted Pair	<u>Data Rate</u>	<u>Distance</u>		<u>Data Rate</u>	<u>Distance</u>	
	4 kb/s	1000 m (3275 ft)		768 kb/s	120 m (400 ft)	
	8 kb/s	1000 m (3275 ft)		1.536 Mb/s	70 m (225 ft)	
	64 kb/s	1000 m (3275 ft)		1.544 Mb/s	70 m (225 ft)	
	256 kb/s	400 m (1300 ft)		2.048 Mb/s	50 m (150 ft)	
	384 kb/s	250 m (825 ft)				
Cable Lengths (maximum in meters and feet; RS-423 [TTL]) 20.1 mils, 0.511 mm (24 AWG) Twisted Pair	<u>Data Rate</u>	<u>Distance</u>				
	4 kb/s	250 m (825 ft)				
	8 kb/s	100 m (325 ft)				
	64 kb/s	15 m (50 ft)				
	100 kb/s and above	Not recommended				
Protection	Stand-alone or 1:N					
SSM Processing	No					

Table O. Card Specifications (Contd)

ITEM	SPECIFICATION					
<b>TOLA 090-40023-02 CARD</b>						
Number of Outputs	5 RS-422 or 10 RS-423 (TTL)					
Output Type	RS-422 or RS-423 (TTL)					
Wave Amplitude	2 V to 6 V pp for RS-422 (balanced) into 100 $\Omega$ >3 V for RS-423 (unbalanced) into 450 $\Omega$					
Wave Shape	Square wave					
Impedance	100 $\Omega$ resistive, balanced; 450 $\Omega$ resistive, unbalanced					
Data Rates (four frequency groups)—From wire-wrap panel	<u>Group</u>	<u>Out 1</u>	<u>Out 2</u>	<u>Out 3</u>	<u>Out 4</u>	<u>Out 5</u>
	0	8 kb/s	8 kb/s	8 kb/s	8 kb/s	8 kb/s
	1	256 kb/s	512 kb/s	2.048 Mb/s	1.544 Mb/s	1.544 Mb/s
	2	384 kb/s	768 kb/s	1.536 Mb/s	1.544 Mb/s	1.544 Mb/s
	3	1.544 Mb/s	1.544 Mb/s	1.544 Mb/s	1.544 Mb/s	1.544 Mb/s
Data Rates (four frequency groups)—From DB9 connector	<u>Group</u>	<u>Out 1</u>	<u>Out 2</u>	<u>Out 3</u>	<u>Out 4</u>	<u>Out 5</u>
	0	8 kb/s	8 kb/s	8 kb/s	8 kb/s	8 kb/s
	1	1.544 Mb/s	1.544 Mb/s	2.048 Mb/s	512 kb/s	256 kb/s
	2	1.544 Mb/s	1.544 Mb/s	1.536 Mb/s	768 kb/s	384 kb/s
	3	1.544 Mb/s	1.544 Mb/s	1.544 Mb/s	1.544 Mb/s	1.544 Mb/s
Cable Lengths (maximum in meters and feet; RS-422) 20.1 mils, 0.511 mm (24 AWG) Twisted Pair	<u>Data Rate</u>	<u>Distance</u>		<u>Data Rate</u>	<u>Distance</u>	
	8 kb/s	1000 m (3275 ft)		768 kb/s	120 m (400 ft)	
	256 kb/s	400 m (1300 ft)		1.536 Mb/s	70 m (225 ft)	
	384 kb/s	250 m (825 ft)		1.544 Mb/s	70 m (225 ft)	
	512 kb/s	200 m (650 ft)		2.048 Mb/s	50 m (150 ft)	
Cable Lengths (maximum in meters and feet; RS-423 [TTL]) 20.1 mils, 0.511 mm (24 AWG) Twisted Pair	<u>Data Rate</u>	<u>Distance</u>				
	8 kb/s	100 m (325 ft)				
	$\geq 100$ kb/s	Not recommended				
Protection	Stand-alone or 1:N					
SSM Processing	No					

Table O. Card Specifications (Contd)

ITEM	SPECIFICATION					
<b>TOLA 090-40023-03 CARD</b>						
Number of Outputs	5					
Output Type	RS-232					
Wave Amplitude	Greater than +3 V from GND and greater than -3 V from GND for RS-232 into 3 k $\Omega$ to 7 k $\Omega$					
Wave Shape	Square wave					
Impedance	100 $\Omega$ resistive, balanced; 450 $\Omega$ resistive, unbalanced					
Data Rates (four frequency groups) - From wire-wrap Module	<u>Group</u>	<u>Out 1</u>	<u>Out 2</u>	<u>Out 3</u>	<u>Out 4</u>	<u>Out 5</u>
	0	4.8 kb/s	4.8 kb/s	4.8 kb/s	4.8 kb/s	4.8 kb/s
	1	9.6 kb/s	9.6 kb/s	9.6 kb/s	9.6 kb/s	9.6 kb/s
	2	19.2 kb/s	19.2 kb/s	19.2 kb/s	19.2 kb/s	19.2 kb/s
	3	56 kb/s	56 kb/s	56 kb/s	56 kb/s	56 kb/s
Cable Lengths (maximum in meters and feet; RS-232) 20.1 mils, 0.511 mm (24 AWG) Twisted Pair	<u>Data Rate</u>	<u>Distance</u>				
	4.8 kb/s	15 m (50 ft)				
	9.6 kb/s	15 m (50 ft)				
	19.2 kb/s	15 m (50 ft)				
	56 kb/s	Not recommended				
Protection	Stand-alone or 1:N					
SSM Processing	No					
<b>TOLA 090-40023-04 CARD</b>						
Number of Outputs	5					
Output Type	RS-422					
Wave Amplitude	2 V to 6 V p-p for RS-422 (balanced) into 100 $\Omega$					
Wave Shape	Square wave					
Impedance	100 $\Omega$ resistive, balanced					
Data Rates	All data rates are 2.048 Mb/s					
Cable Lengths (maximum in meters and feet; RS-422) 20.1 mils, 0.511 mm (24 AWG) Twisted Pair	<u>Data Rate</u>	<u>Distance</u>				
	2.048 Mb/s	50 m (150 ft)				
Protection	Stand-alone or 1:N					
SSM Processing	No					

Table O. Card Specifications (Contd)

ITEM	SPECIFICATION					
TOLA 090-40023-05 CARD						
Number of Outputs	5 RS-422 or 10 RS-423 (TTL)					
Output Type	RS-422 or RS-423 (TTL)					
Wave Amplitude	2 V to 6 V p-p for RS-422 (balanced) into 100 $\Omega$ >3 V for RS-423 (unbalanced) into 450 $\Omega$					
Wave Shape	Square wave					
Impedance	100 $\Omega$ resistive, balanced; 450 $\Omega$ resistive, unbalanced					
Data Rates (four frequency groups)—From wire-wrap panel	<u>Group</u>	<u>Out 1</u>	<u>Out 2</u>	<u>Out 3</u>	<u>Out 4</u>	<u>Out 5</u>
	0	1.544 Mb/s	64 kb/s	128 kb/s	192 kb/s	1.024 Mb/s
	1	1.544 Mb/s	64 kb/s	128 kb/s	192 kb/s	1.024 Mb/s
	2	1.544 Mb/s	64 kb/s	128 kb/s	192 kb/s	1.024 Mb/s
	3	1.544 Mb/s	64 kb/s	128 kb/s	192 kb/s	1.024 Mb/s
Data Rates (four frequency groups)—From DB9 connector	<u>Group</u>	<u>Out 1</u>	<u>Out 2</u>	<u>Out 3</u>	<u>Out 4</u>	<u>Out 5</u>
	0	1.024 Mb/s	192 kb/s	128 kb/s	64 kb/s	1.544 Mb/s
	1	1.024 Mb/s	192 kb/s	128 kb/s	64 kb/s	1.544 Mb/s
	2	1.024 Mb/s	192 kb/s	128 kb/s	64 kb/s	1.544 Mb/s
	3	1.024 Mb/s	192 kb/s	128 kb/s	64 kb/s	1.544 Mb/s
Cable Lengths (RS-422) 20.1 mils, 0.511 mm (24 AWG) Twisted Pair (maximum in meters and feet)	<u>Data Rate</u>	<u>Distance</u>	<u>Data Rate</u>	<u>Distance</u>		
	64 kb/s	1000 m (3275 ft)	1.024 Mb/s	91 m (300 ft)		
	128 kb/s	400 m (1300 ft)	1.544 Mb/s	70 m (225 ft)		
	192 kb/s	400 m (1300 ft)				
Cable Lengths (RS-423 [TTL]) 20.1 mils, 0.511 mm (24 AWG) Twisted Pair (maximum in meters and feet)	<u>Data Rate</u>	<u>Distance</u>				
	64 kb/s	15.2 m (50 ft)				
	$\geq 100$ kb/s	Not recommended				
Protection	Stand-alone or 1:N					
SSM Processing	No					

Table O. Card Specifications (Contd)

ITEM	SPECIFICATION																														
<b>TOLA 090-40023-06 CARD</b>																															
Number of Outputs	5 RS-422 or 10 RS-423 (TTL)																														
Output Type	RS-422 or RS-423 (TTL)																														
Wave Amplitude	2 V to 6 V p-p for RS-422 (balanced) into 100 $\Omega$ >3 V for RS-423 (unbalanced) into 450 $\Omega$																														
Wave Shape	Square wave																														
Impedance	100 $\Omega$ resistive, balanced; 450 $\Omega$ resistive, unbalanced																														
Data Rates (four frequency groups)—From wire-wrap panel or from DB9 connector	<table border="1"> <thead> <tr> <th>Group</th> <th>Out 1</th> <th>Out 2</th> <th>Out 3</th> <th>Out 4</th> <th>Out 5</th> </tr> </thead> <tbody> <tr> <td>0</td> <td>4.8 kb/s</td> <td>4.8 kb/s</td> <td>4.8 kb/s</td> <td>4.8 kb/s</td> <td>4.8 kb/s</td> </tr> <tr> <td>1</td> <td>9.6 kb/s</td> <td>9.6 kb/s</td> <td>9.6 kb/s</td> <td>9.6 kb/s</td> <td>9.6 kb/s</td> </tr> <tr> <td>2</td> <td>19.2 kb/s</td> <td>19.2 kb/s</td> <td>19.2 kb/s</td> <td>19.2 kb/s</td> <td>19.2 kb/s</td> </tr> <tr> <td>3</td> <td>56 kb/s</td> <td>56 kb/s</td> <td>56 kb/s</td> <td>56 kb/s</td> <td>56 kb/s</td> </tr> </tbody> </table>	Group	Out 1	Out 2	Out 3	Out 4	Out 5	0	4.8 kb/s	4.8 kb/s	4.8 kb/s	4.8 kb/s	4.8 kb/s	1	9.6 kb/s	9.6 kb/s	9.6 kb/s	9.6 kb/s	9.6 kb/s	2	19.2 kb/s	19.2 kb/s	19.2 kb/s	19.2 kb/s	19.2 kb/s	3	56 kb/s	56 kb/s	56 kb/s	56 kb/s	56 kb/s
Group	Out 1	Out 2	Out 3	Out 4	Out 5																										
0	4.8 kb/s	4.8 kb/s	4.8 kb/s	4.8 kb/s	4.8 kb/s																										
1	9.6 kb/s	9.6 kb/s	9.6 kb/s	9.6 kb/s	9.6 kb/s																										
2	19.2 kb/s	19.2 kb/s	19.2 kb/s	19.2 kb/s	19.2 kb/s																										
3	56 kb/s	56 kb/s	56 kb/s	56 kb/s	56 kb/s																										
RS-422 20.1 mils, 0.511 mm (24 AWG) Twisted Pair (maximum in meters and feet)	<table border="1"> <thead> <tr> <th>Data Rate</th> <th>Distance</th> </tr> </thead> <tbody> <tr> <td><math>\leq</math>56 kb/s</td> <td>1000 m (3275 ft)</td> </tr> </tbody> </table>	Data Rate	Distance	$\leq$ 56 kb/s	1000 m (3275 ft)																										
Data Rate	Distance																														
$\leq$ 56 kb/s	1000 m (3275 ft)																														
RS-423 (TTL) 20.1 mils, 0.511 mm (24 AWG) Twisted Pair (maximum in meters and feet)	<table border="1"> <thead> <tr> <th>Data Rate</th> <th>Distance</th> </tr> </thead> <tbody> <tr> <td>4 kb/s</td> <td>250 m (825 ft)</td> </tr> <tr> <td>8 kb/s</td> <td>100 m (325 ft)</td> </tr> <tr> <td>56 kb/s</td> <td>15 m (50 ft)</td> </tr> </tbody> </table>	Data Rate	Distance	4 kb/s	250 m (825 ft)	8 kb/s	100 m (325 ft)	56 kb/s	15 m (50 ft)																						
Data Rate	Distance																														
4 kb/s	250 m (825 ft)																														
8 kb/s	100 m (325 ft)																														
56 kb/s	15 m (50 ft)																														
Protection	Stand-alone or 1:N																														
SSM Processing	No																														



Table O. Card Specifications (Contd)

ITEM	SPECIFICATION					
<b>TOLA 090-40023-07 CARD</b>						
Number of Outputs	5 RS-422 or 10 RS-423 (TTL)					
Output Type	RS-422 or RS-423 (TTL)					
Wave Amplitude	2 V to 6 V p-p for RS-422 (balanced) into 100 $\Omega$ >3 V for RS-423 (unbalanced) into 450 $\Omega$					
Wave Shape	Square wave					
Impedance	100 $\Omega$ resistive, balanced; 450 $\Omega$ resistive, unbalanced					
Data Rates (four frequency groups)—From wire-wrap panel or from DB9 connector	<u>Group</u>	<u>Out 1</u>	<u>Out 2</u>	<u>Out 3</u>	<u>Out 4</u>	<u>Out 5</u>
	0	2048 kb/s	2048 kb/s	2048 kb/s	2048 kb/s	2048 kb/s
	1	1024 kb/s	1024 kb/s	1024 kb/s	1024 kb/s	1024 kb/s
	2	512 kb/s	512 kb/s	512 kb/s	512 kb/s	512 kb/s
	3	256 kb/s	256 kb/s	256 kb/s	256 kb/s	256 kb/s
RS-422 20.1 mils, 0.511 mm (24 AWG) Twisted Pair (maximum in meters and feet)	<u>Data Rate</u>	<u>Distance</u>		<u>Data Rate</u>	<u>Distance</u>	
	256 kb/s	400 m (1300 ft)		1.024 Mb/s	91 m (300 ft)	
	512 kb/s	200 m (650 ft)		2.048 Mb/s	50 m (150 ft)	
RS-423 (TTL) 20.1 mils, 0.511 mm (24 AWG) Twisted Pair (maximum in meters and feet)	<u>Data Rate</u>	<u>Distance</u>				
	$\geq 100$ kb/s	Not recommended				
Protection	Stand-alone or 1:N					
SSM Processing	No					
<b>TOTL CARD</b>						
Number of Outputs	10					
Output Type	DS1					
Waveform	2.4 V to 3.6 V peak, 3.5 V nominal; bipolar return to zero, all-ones; ESF or D4 format					
Wave Shape	Rectangular, rise time <150 ns, pulse width 350 ns $\pm 50$ ns, pulse interval 648 ns $\pm 0.005\%$					
Impedance	100 $\Omega$ balanced					
Overshoot	Peak-to-base A +20% and -45%					
Duty Cycle	50% nominal					
Output Drive Capability	0 m to 198.7 m (0 ft to 655 ft) of twisted-pair, 25.3 mils, 0.643 mm (22 AWG) ABAM cable					
Protection	Stand-alone or 1:N					
SSM Processing	No					

Table O. Card Specifications (Contd)

ITEM	SPECIFICATION
<b>ESCIU CARD</b>	
Input	Bidirectional E1
E1 Input, A and B	Framed E1 2.048 Mb/s
Input Monitor	LOS or AIS, OOF
Input Error Threshold	2 out of 4 OOF, 32 consecutive zeroes
Framing Protocols	CAS, CCS; with or without HDB3 or AMI line coding
Input Signal Level, Terminated	2.375 V $\pm$ 10% into 75 $\Omega$ (per ITU G.703)
Input Signal Level, Bridging	Bridging resistance is $\leq$ 422 $\Omega$ x 2 (20 dB)
Input Signal Level, Impedance	75 $\Omega$ unbalanced
Input Signal Level, Jitter Tolerance	Meets ITU G.823 requirements
E1 Output, Levels A and B	Meets ITU G.703 requirements
E1 A Buffer Size	$\pm$ 256 bits ( $\pm$ 1 frame)
E1 A Buffer Hysteresis	64 bits, approximately 40 $\mu$ s
E1 A Through Delay	$\geq$ 16 $\mu$ s, 136 $\mu$ s centered, $\leq$ 266 $\mu$ s (2 E1 frames + 16 $\mu$ s)
E1 B Through Delay	Nominal 16 $\mu$ s
Protection	Stand-alone
SSM Processing	No

Table O. Card Specifications (Contd)

ITEM	SPECIFICATION
<b>SCIU CARD</b>	
Input	Bidirectional DS1
DS1 Input, A and B	Message DS1 1.544 Mb/s (framed or unframed)
Input Monitor	LOS or AIS, OOF
Input Error Threshold	2 out of 4 OOF, 32 consecutive zeroes
Framing Protocols	D4, ESF; with or without B8ZS or AMI
Input Signal Level, Terminated	1.5 V to 4.5 V base-to-peak (DSX-1)
Input Signal Level, Bridging	0.15 V to 0.45 V base-to-peak
Impedance	100 $\Omega$ balanced
Input Signal Level, Jitter Tolerance	10 UI p-p, 0.31 to 10 kHz; 0.3 UI p-p, 10 to 100 kHz (per T1.102)
DS1 Output, Levels A and B	3 V base-to-peak nominal before line build-out preemphasis (per ANSI T1.102-1988)
DS1 Output Impedance	100 $\Omega$
Residual Jitter Output, DS1 A	0.025 UI with rubidium clock source; 0.1 UI with quartz clock source, 0.05 kHz to 100 kHz
DS1 A Buffer Size	$\pm 192$ bits ( $\pm 1$ frame)
DS1 A Buffer Hysteresis	64 bits, approximately 40 $\mu$ s
DS1 A Through Delay	Nominal 125 $\mu$ s; $\leq 250$ $\mu$ s
DS1 B Through Delay	Nominal 2.6 $\mu$ s; $\leq 5.2$ $\mu$ s
Protection	Stand-alone
SSM Processing	No

Table O. Card Specifications (Contd)

ITEM	SPECIFICATION
<b>PSM-E CARD AND PSM-E<sup>V5</sup> CARD</b>	
Number of Inputs	4
Input Signal Type	E1 Digital (ITU G.703, Table 6)
Input Impedance	120 $\Omega$ balanced or 75 $\Omega$ unbalanced
Input Parameters Monitored	CRC, OOF, BPV, AIS, LOS, MTIE, TDEV, raw phase
Factory-set Thresholds (all except LOS may be changed by TL1 commands)	AIS: 1 BPV: 16 CRC: 16 LOS:1 OOF: 1
Framing Protocols	CAS and CCS framing with/without CRC-4 per ITU G.704, unframed
Line Coding	HDB3
Scan Rate	5 s per active channel (inactive channels are not scanned)
Sample Rate	1 Hz per channel
Input Signal Level, Terminated	1.0 V to 3.5 V base-to-peak
Input Signal Level, Bridged	0.1 V to 0.35 V base-to-peak
Protection	Stand-alone
SSM Processing	No

Table O. Card Specifications (Contd)

ITEM	SPECIFICATION
<b>PSM-EA<sup>V5</sup> CARD</b>	
Number of Inputs	4
Input Signal Type	Digital (ITU G.703, Table 6) 2.048 MHz (ITU G.703, Table 10)
Input Impedance	120 $\Omega$ balanced or 75 $\Omega$ unbalanced
Input Parameters Monitored	CRC, OOF, BPV, AIS, LOS, MTIE, TDEV, raw phase
Factory-set Thresholds (all except LOS may be changed by TL1 commands)	AIS: 1 BPV: 16 CRC: 16 LOS:1 OOF: 1
Framing Protocols	CAS and CCS framing with/without CRC-4 per ITU G.704, unframed
Line Coding	HDB3
Scan Rate	5 s per active channel (inactive channels are not scanned)
Sample Rate	1 Hz per channel
Input Signal Level, Terminated	1.0 V to 3.5 V base-to-peak
Input Signal Level, Bridged	0.1 V to 0.35 V base-to-peak
Protection	Stand-alone
SSM Processing	No

Table O. Card Specifications (Contd)

ITEM	SPECIFICATION
<b>PSM-T CARD AND PSM-T<sup>V5</sup> CARD</b>	
Number of Inputs	4
Input Signal Type	DS1
Input Impedance	120 $\Omega$ balanced
Input Parameters Monitored	CRC, OOF, BPV, AIS, LOS, MTIE, TDEV, raw phase
Factory-set Thresholds (all except LOS may be changed by TL1 commands)	CRC:16 OOF: 4 BPV: 16 AIS: 4 LOS:1
Framing Protocols	ESF or D4
Line Coding	AMI, B8ZS
Scan Rate	5 s per active channel (inactive channels are not scanned)
Sample Rate	1 Hz per channel
Input Signal Level, Terminated	1.0 V to 3.5 V base-to-peak
Input Signal Level, Bridged	0.1 V to 0.35 V base-to-peak
Protection	Stand-alone
SSM Processing	No
<b>SAI CARD</b>	
Relay Contact Ratings	2 A, resistive load
Audible and Visual Alarms (major and minor)	Normally open and normally closed contacts
Alarm Status Indication (major and minor)	Normally open contacts
Status Leads	Open collector PNP, 120 V, 50 mA nominal, $\leq$ 500 mA; E2A, TASC type alarm points (RTN [Return] lead at ground; active lead 5 $\Omega$ to 7 $\Omega$ from ground when activated)

Table O. Card Specifications (Contd)

ITEM	SPECIFICATION		
<b>MIS CARD AND MIS<sup>V5</sup> CARD</b>			
Relay Contact Ratings	2 A, resistive load		
Audible and Visual Alarms (major, minor, and critical)	Normally open and normally closed contacts		
Alarm Status Indication (major, minor, and critical)	Normally open contacts		
Status Leads	Open collector PNP, 120 V, 50 mA nominal, 500 mA; E2A, TASC type alarm points (RTN [Return] lead at ground; active lead 5 Ω to 7 Ω from ground when activated)		
Physical Interface Backplane MIS Card Front Panel	DB9 RJ45		
Electrical Interface (All Ports)	RS-232C		
Configuration (All Ports)	Data communications equipment (DCE)		
Language (All Ports)	TL1		
Communications Settings	<u>COMM1</u>	<u>COMM2</u>	<u>COMM3</u>
	9600 or 1200 baud (set by TL1 command)	9600 or 1200 baud (set by card switch)	9600 or 1200 baud (set by TL1 command)
	8 data bits	8 data bits	8 data bits
	even, odd, or no parity (set by TL1 command)	even, odd, or no parity (set by card switch)	even, odd, or no parity (set by TL1 command)
	1 stop bit	1 stop bit	1 stop bit
	Notes: 1. Settings are the same for COM2 or the RJ45 front-panel jack. 2. Either COM2 or the RJ45 front-panel jack are active, not both. 3. For additional communications settings, see the commands in the MIS card TL1 User's Guide.		

Table P. Specification Terms

TERM	MEANING
Accuracy (20 years) (As used here, refers only to frequency accuracy, not time accuracy)	Represents the degree to which the measured frequency characteristics of an oscillator, that is not influenced by a reference signal or control circuitry, conforms to a defined value. For example, a 1 MHz signal that has an accuracy of 1 part in $10^{-6}$ can deviate $\pm 1$ Hz from 1,000,000 Hz.
Convergence Time	The time required to bring the local oscillator within $10^{-10}$ of the reference signal.
Holdoff Delay	The amount of time from when transmission impairments are detected on an input until the input is disqualified.
Holdover Message Delay	The amount of time from when the clocks go into holdover until the holdover SSM is sent to the timing output cards.
Holdover Stability	Specifies the rate at which a clock, which is no longer influenced by a reference signal, changes from its nominal frequency over a certain period of time (e.g., 24 hours, 48 hours). (Stability is broadly categorized into short and long term periods. Short term stability is dominated by random noise and jitter, whereas long term stability is dominated by drift.)
Input Tolerance	The amount by which the input reference signal can change with respect to the average of the sampled input signal over the last 24 hours. If the input signal changes by a value greater than this specified limit, the clock will declare an alarm and enter a hold-over mode.
Lock Range	Represents the frequency difference between the current input signal sample value and the center frequency lock value of the clock for which locking is possible.
Nonswitching Message Delay	The amount of time from a signal quality SSM change (following the persistence delay and which does not require a switch or rearrangement) at an input until the new SSM is sent to the timing output cards.
Operating Temperature	The temperature range over which the specifications are met unless specifically stated otherwise.
Persistence Delay	The amount of time from an SSM change at an input until the new SSM is sent to the MIS card.
Pull-in Range	The largest offset between the actual input reference frequency and the nominal reference frequency within which the slave clock will always lock.
Wait-to-Restore Delay	The amount of time from when the input is free of transmission impairments until the input is requalified for use on a DCIM card.
Storage Temperature	The temperature range over which the card can be stored without damage.
Switching Message Delay	The amount of time from a signal quality SSM change (following the persistence delay and which requires a switch or rearrangement) at an input until the new SSM is sent to the timing output cards.
Warm-up Time	The time required to stabilize the temperature-regulating element surrounding the oscillator.